

°Profil aluminiovy wytłaczanie

°dissipateur aluminium profilé

°aluminiovy radiator
producentów i radiatory
dla procesorów

°Profil aluminiovy wytłaczanie i
Radiator LED

°CNC Machining Parts

°Custom doprowadziły światła radiatora
profile aluminiovy

°Aluminiova obudowa box projektu elektroniki pcb

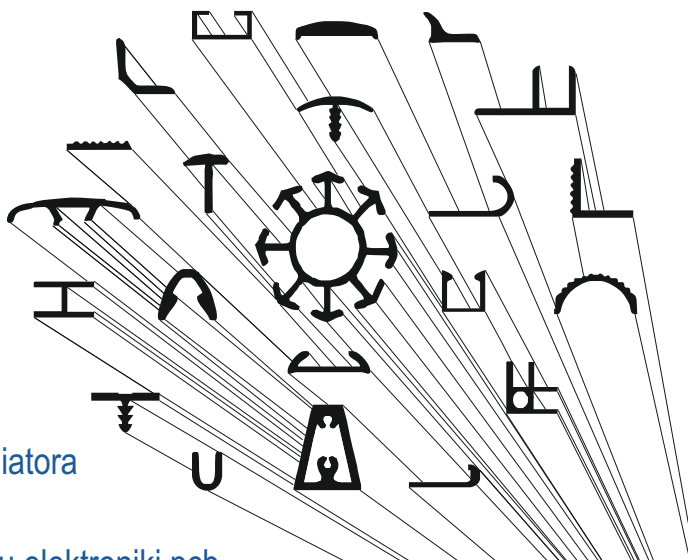

OMAR s.r.l.
PROFILATI ALLUMINIO
ALTA TECNOLOGIA

Le "molte forme" della billetta d'alluminio
Profil aluminiovy wytłaczanie

Edizione Febbraio 2017

E.catalogue:

www.omar-alluminio.it

www.omar-alluminio.com

www.dissipatori.com

°T-Slotted systemy modułowe aluminiovy

System modułowy

°Pneumatyka anodowane
aluminium Rury okrągłe

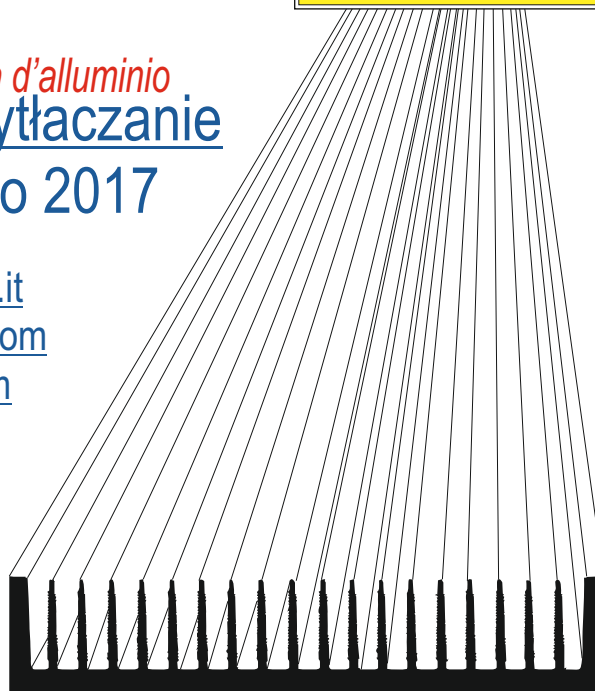
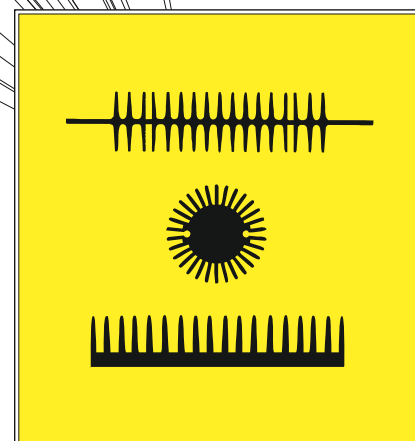

Via Newton, n.12
20016 Pero (Milano - Italy)
Tel.+39 02 3535955 r.a.
Fax.+39 02 3539929
E.Mail: info@omar-alluminio.it

PROFILATI IN ALLUMINIO
A DISEGNO-STANDARD-SPECIALI



ED: ELETTRONICA-LED-FOTOVOLTAICO
AUTOMAZIONE-ROBOTICA-PNEUMATICA-AUTOMOTIVE

Via Newton, n.12
20016 Pero (Milano - Italy)
Tel. +39 02 3535955 r.a. Fax. +39 02 3539929
E. Mail: info@omar-alluminio.it

Cataloghi Online: www.omar-alluminio.it
www.omar-alluminio.com

PROFILATI ALLUMINIO A DISEGNO / STANDARD / SPECIALI / E PER:
ELETTRONICA / LED / FOTOVOLTAICO / AUTOMAZIONE ROBOTICA / PNEUMATICA / AUTOMOTIVE

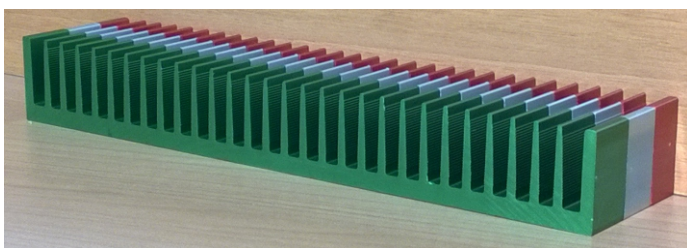
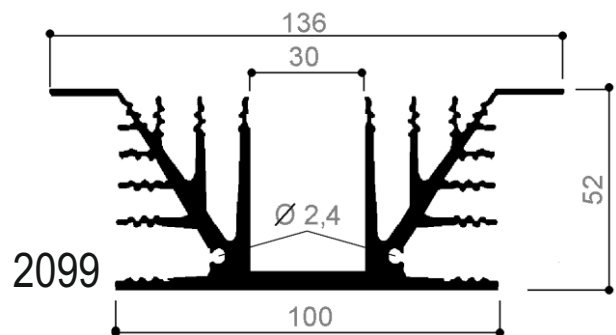
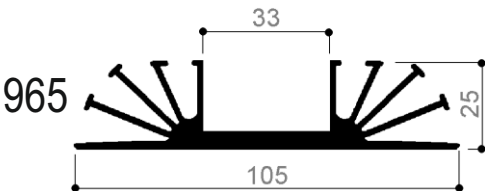
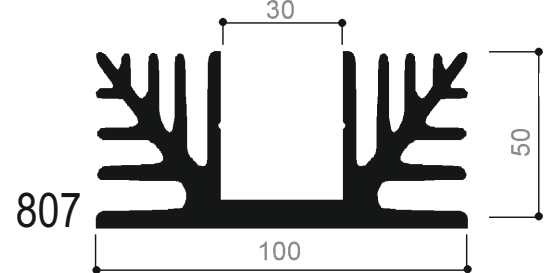
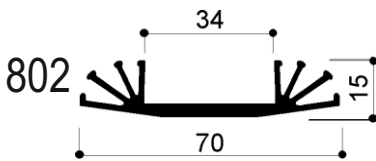
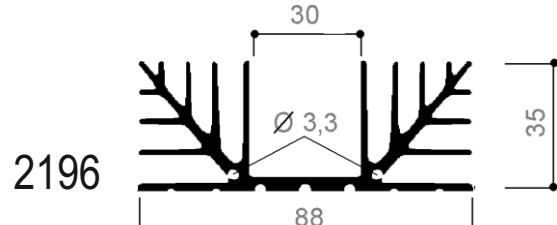
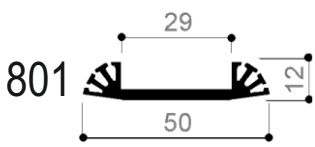
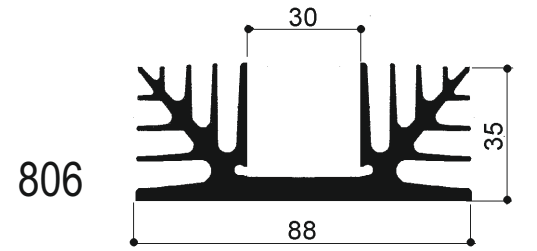
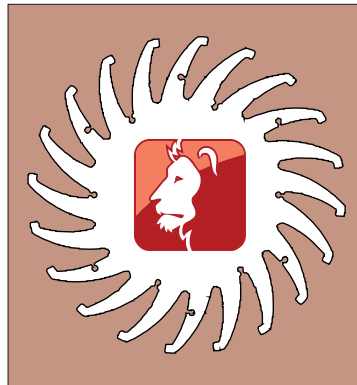
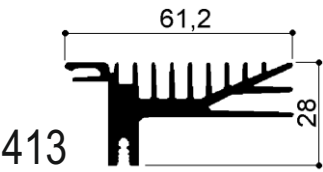
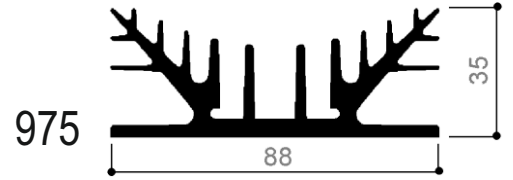
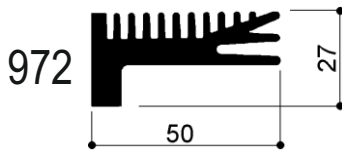
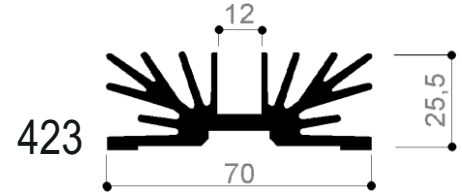
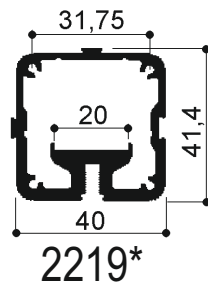
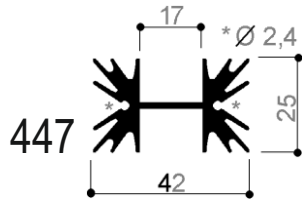
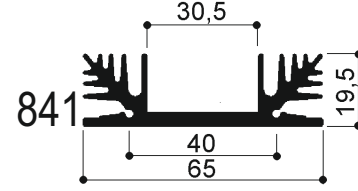
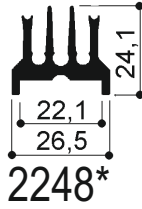
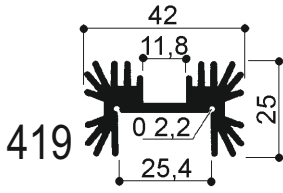
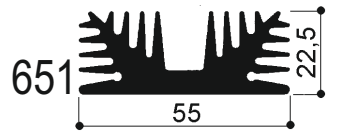
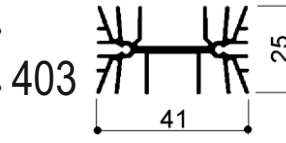
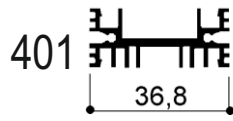
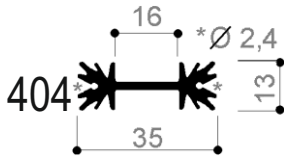
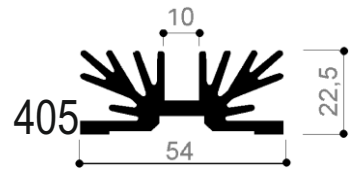
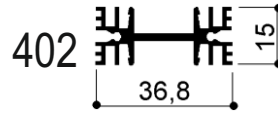
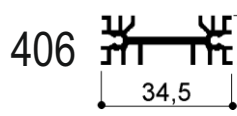
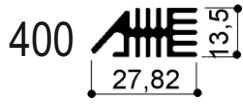

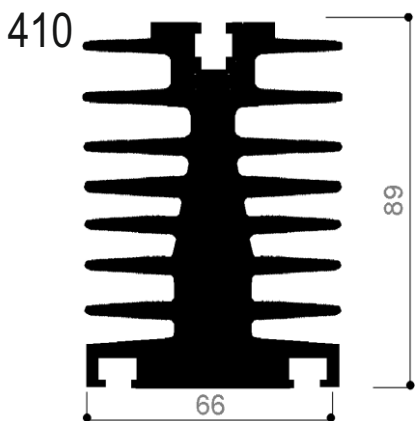
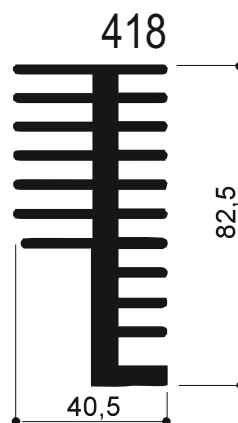
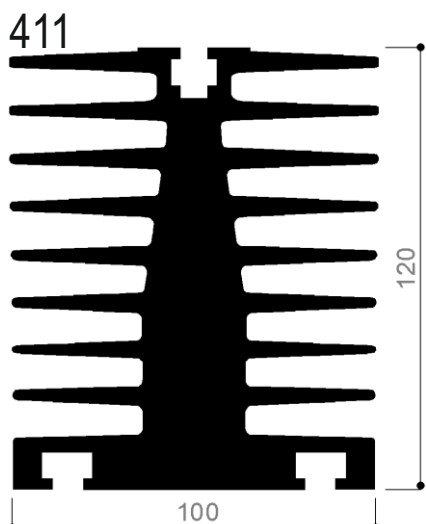
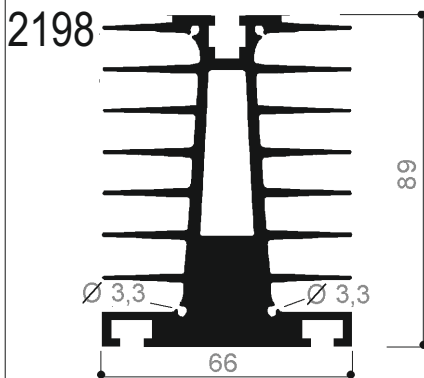
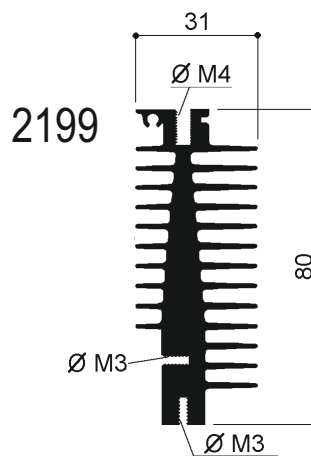
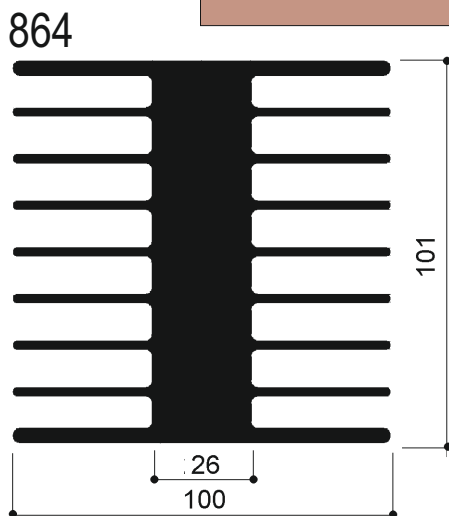
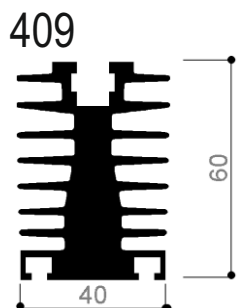
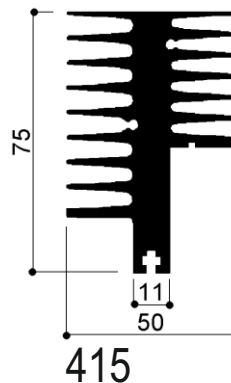
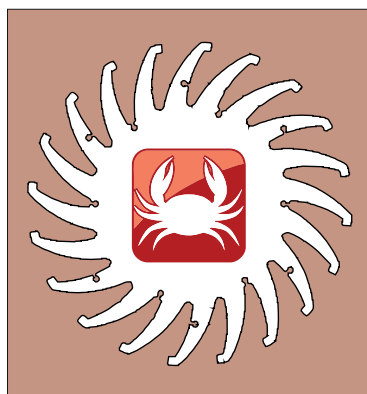
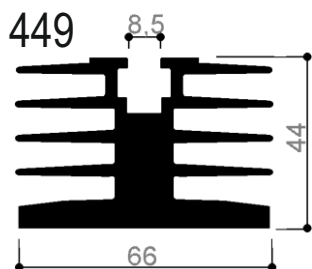
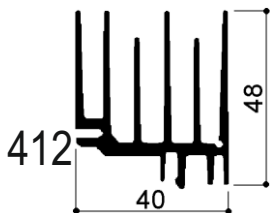
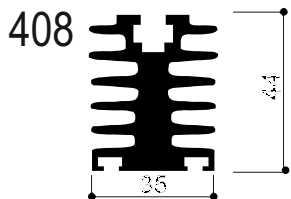
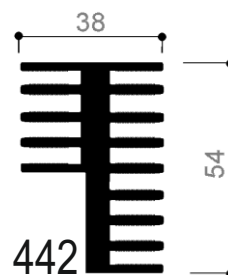
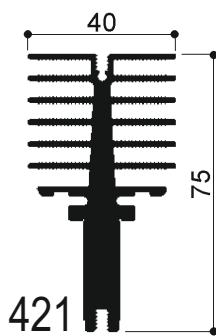
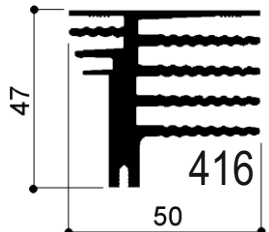
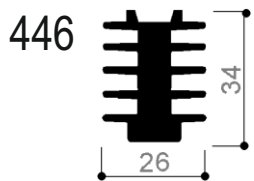

Via Newton, n.12
20016 Pero (Milano - Italy)
Tel. +39 02 3535955 r.a. Fax. +39 02 3539929
E-Mail: info@omar-alluminio.it

Cataloghi Online: www.omar-alluminio.it
www.omar-alluminio.com

PROFILATI ALLUMINIO A DISEGNO / STANDARD / SPECIALI / E PER:
ELETTRONICA / LED / FOTOVOLTAICO / AUTOMAZIONE ROBOTICA / PNEUMATICA / AUTOMOTIVE





DISEGNI META' DEL VERO (1:2)- SCALE 1:2



FOTO DI ESEMPIO: SI ESEGUONO LAVORAZIONI MECCANICHE SU PROFILI ESTRUSI IN ALLUMINIO



FOTO DI ESEMPIO: DISSIPATORI A DOPPIO PETTINE DI GRANDI DIMENSIONI (mm 300 x 65mm kg/mt 16 circa)

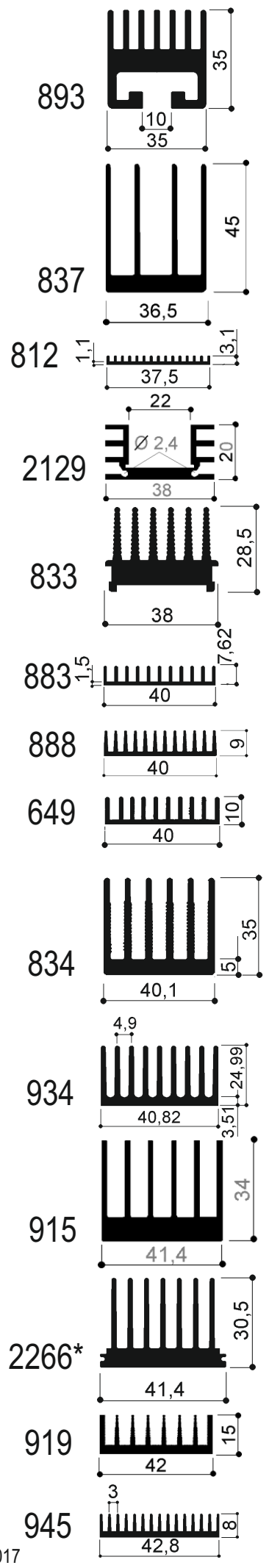
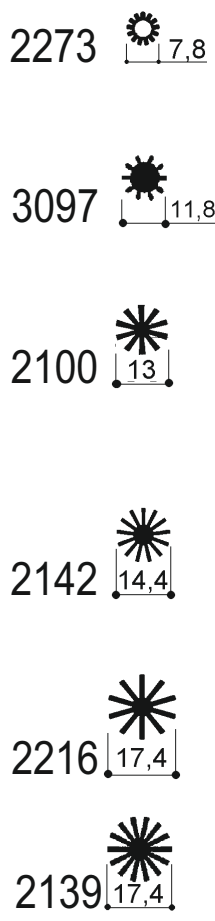
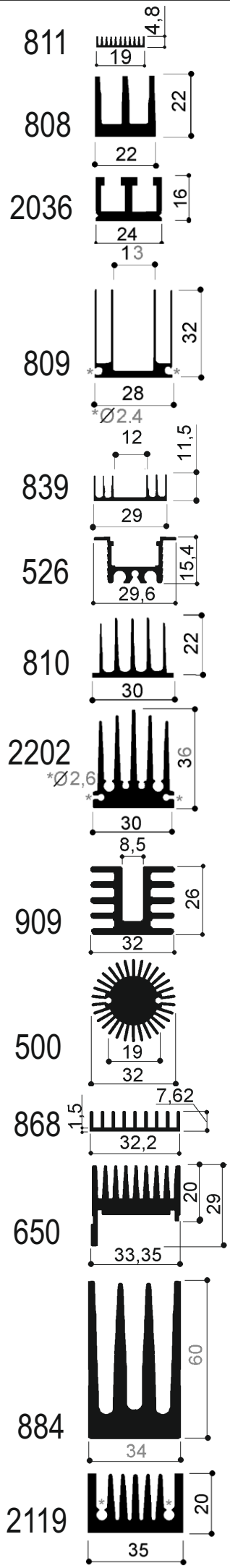

2074D46

2075

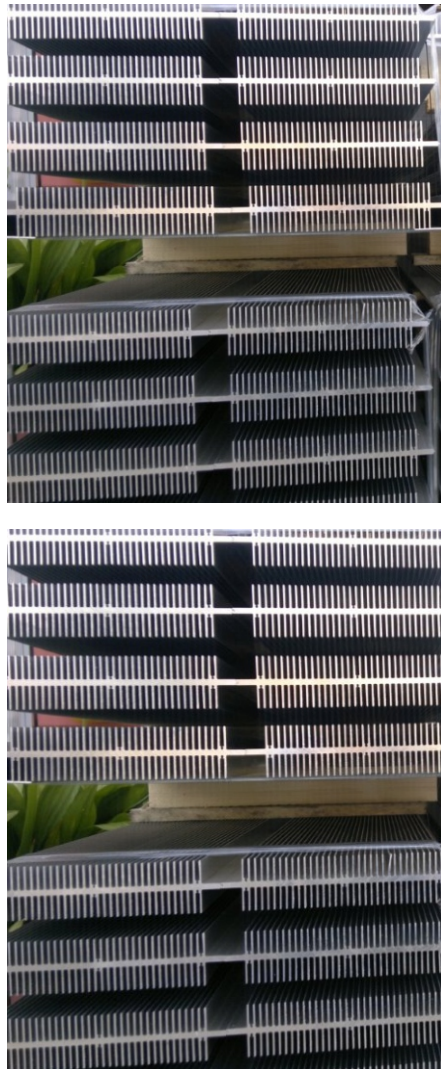
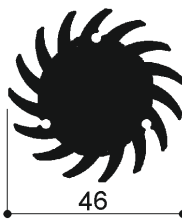
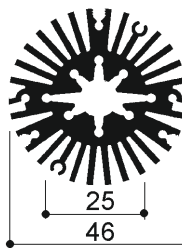
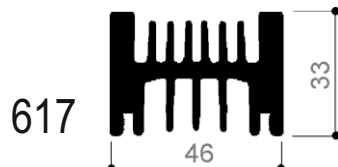
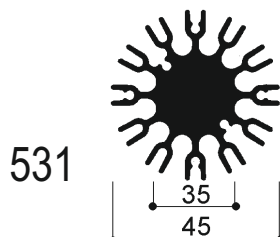
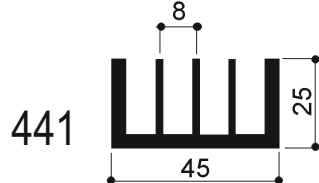
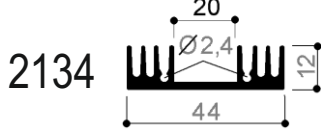
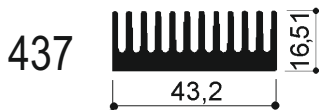
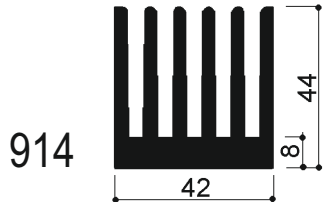
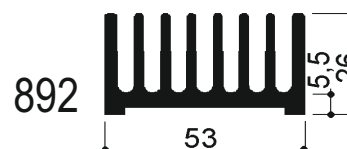
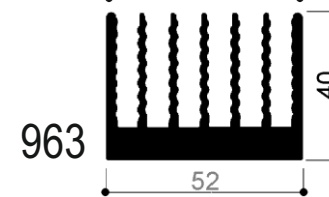
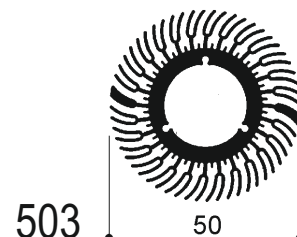
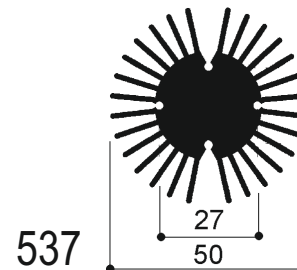
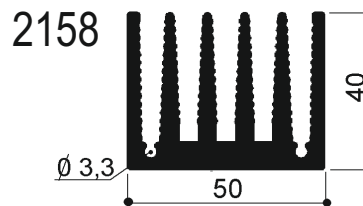
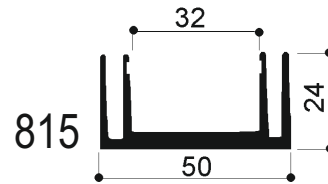
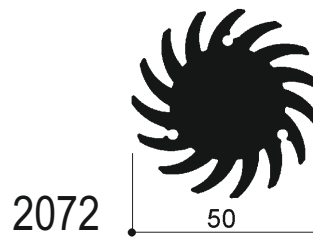
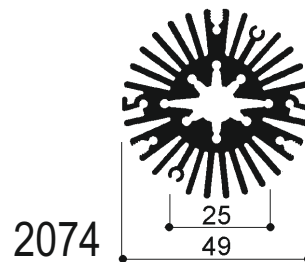
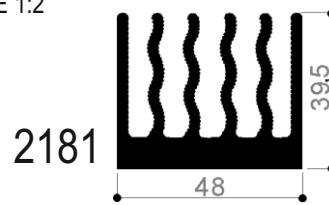
2072D46

882

503

963

944

892

DISEGNI META' DEL VERO (1:2)- SCALE 1:2

916

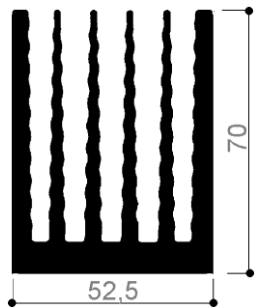

863



857

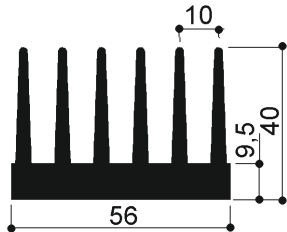

939

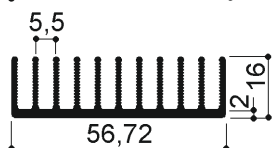

856

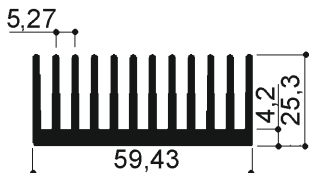

505

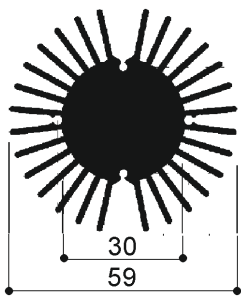

816

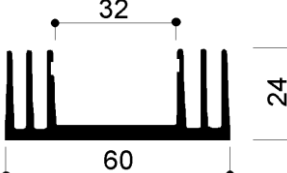

938

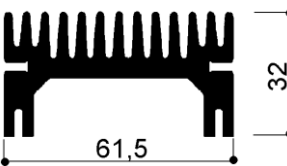

832



951

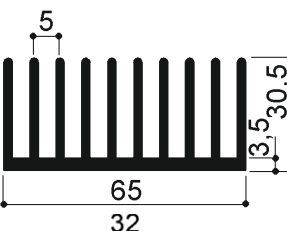

817

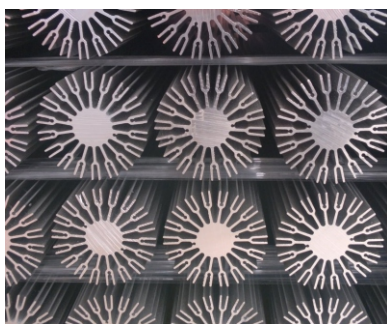
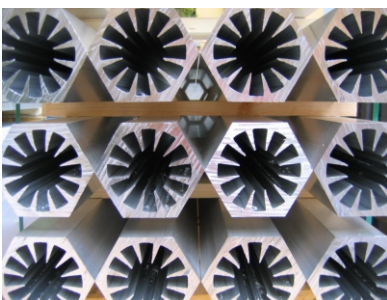
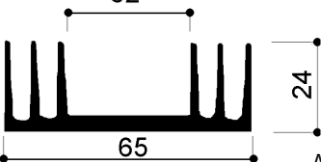

2073D70

813

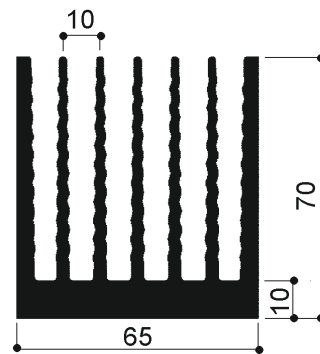

906

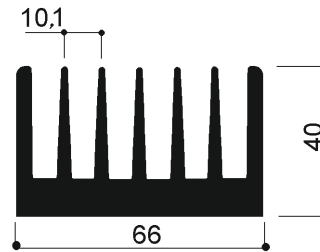

2112

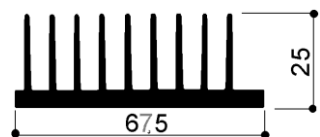

2176

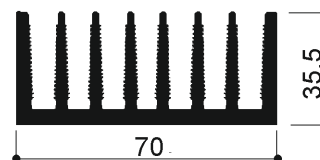

831

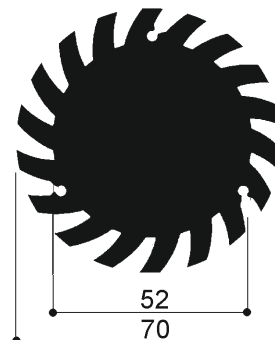

867

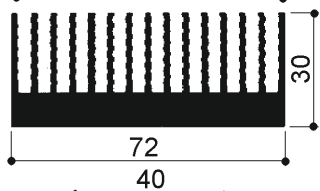

842

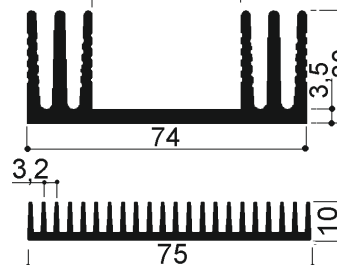

858

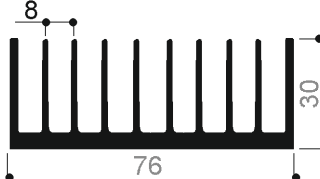

869

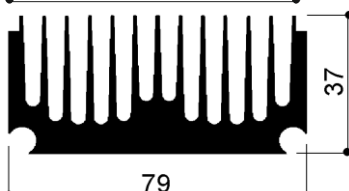

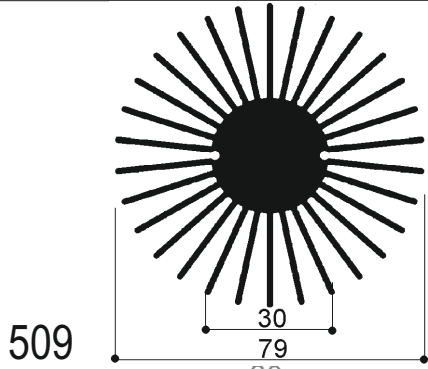

509

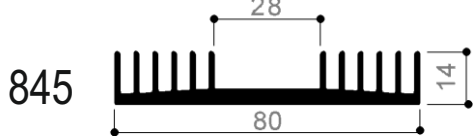

845

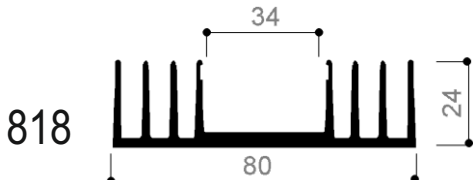

818

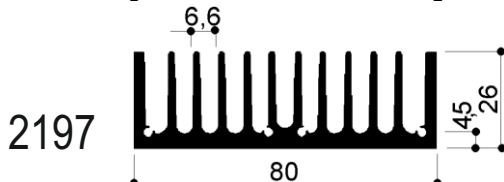

2197



997

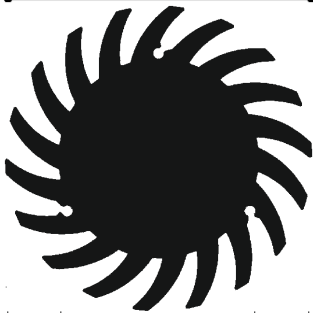

2073

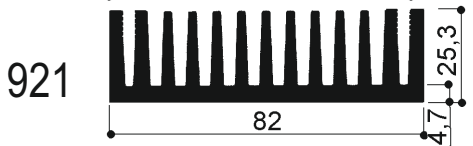
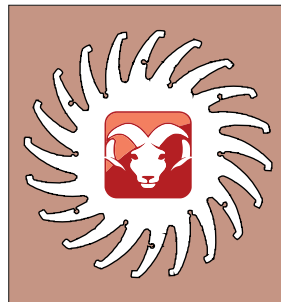

921

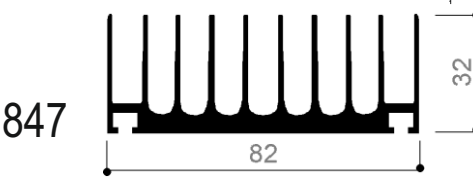

847

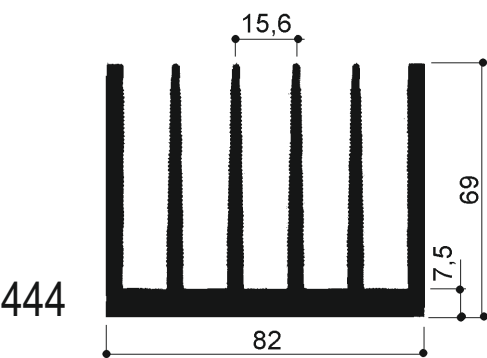

444

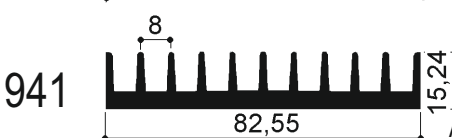

941

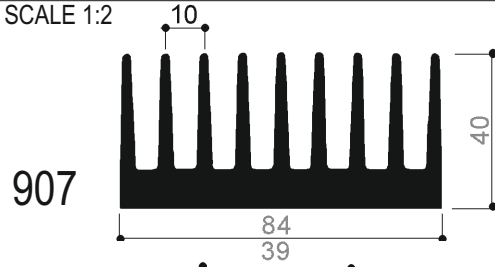

907

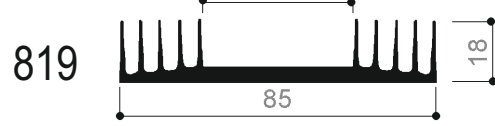

819

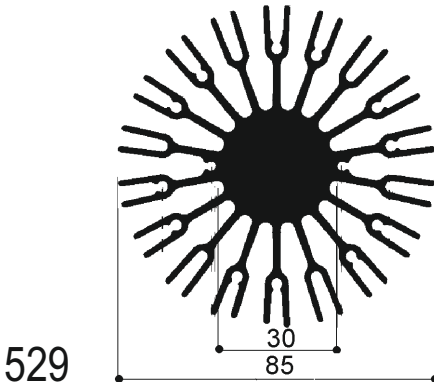

529

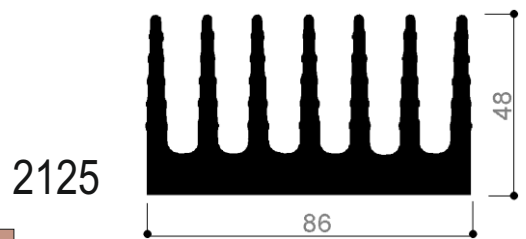

2125

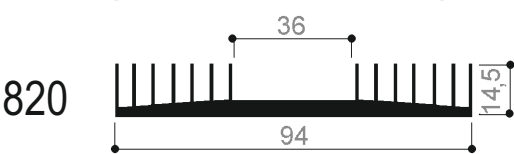

820

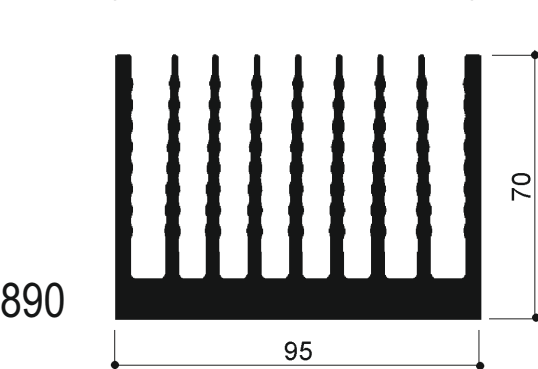

890

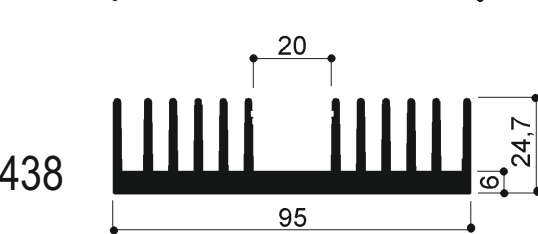

438

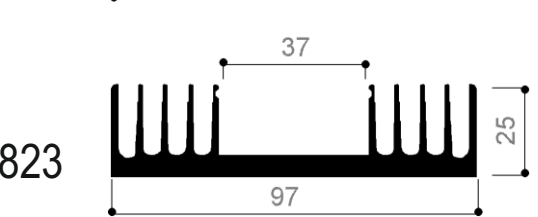

823

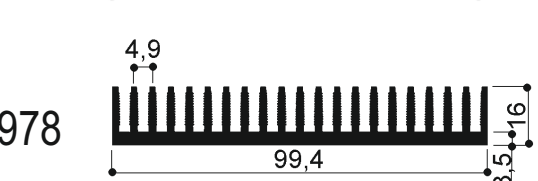

978

Via Newton, n.12
 20016 Pero (Milano - Italy)
 Tel. +39 02 3535955 r.a. Fax. +39 02 3539929
 E.Mai: info@omar-alluminio.it

Cataloghi Online: www.omar-alluminio.it
 www.omar-alluminio.com

PROFILATI ALLUMINIO A DISEGNO / STANDARD / SPECIALI / E PER:
 ELETTRONICA / LED / FOTOVOLTAICO / AUTOMAZIONE ROBOTICA / PNEUMATICA / AUTOMOTIVE

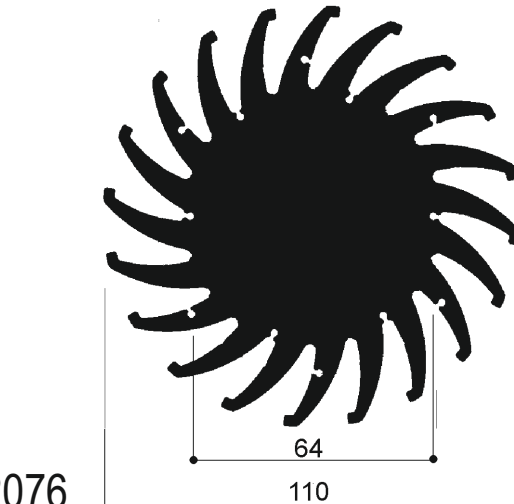
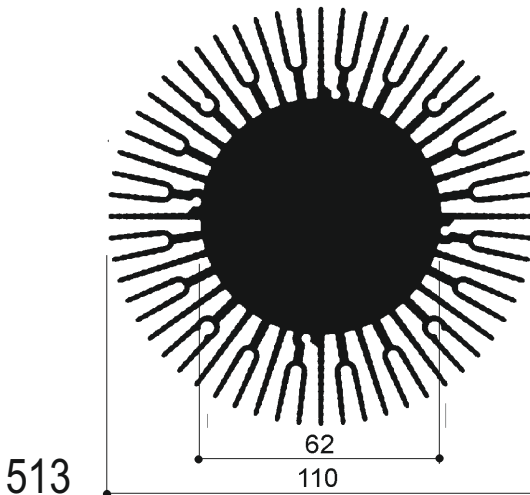
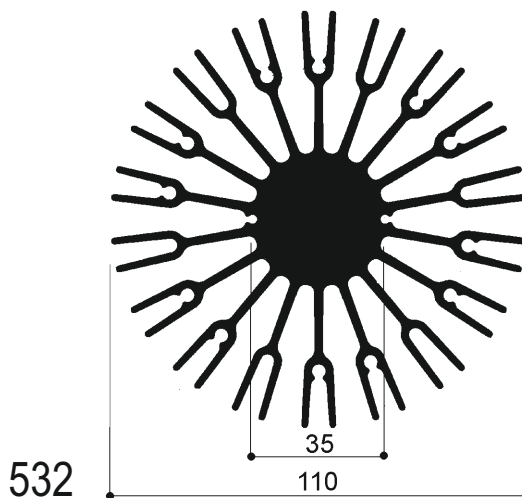
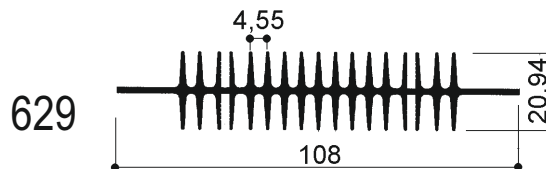
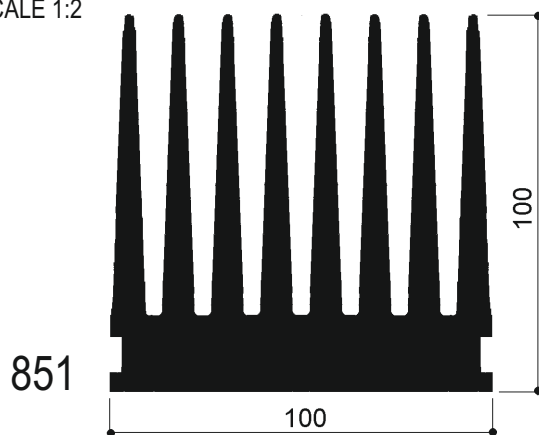
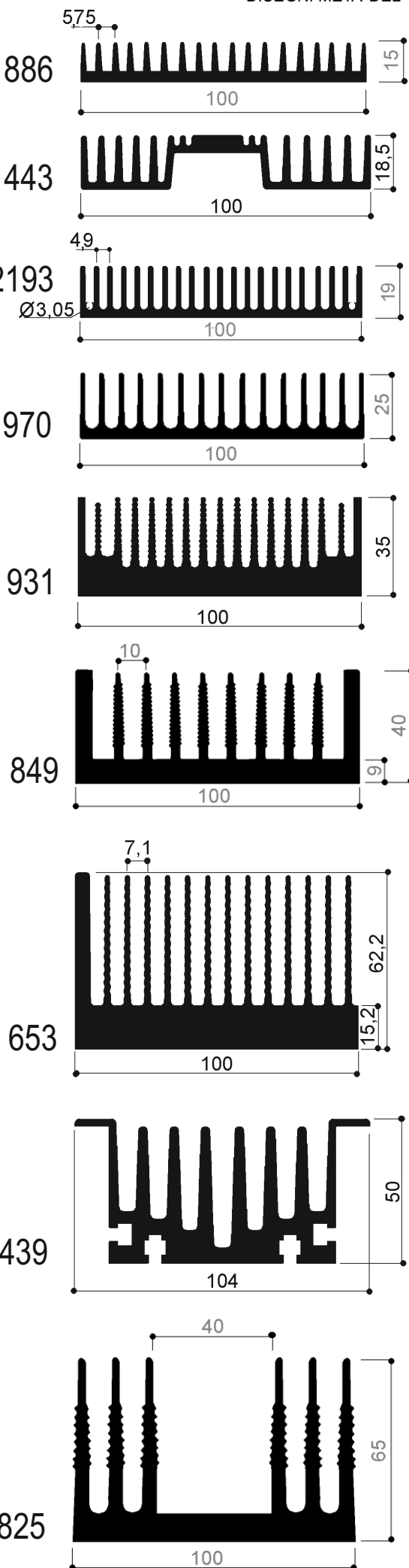

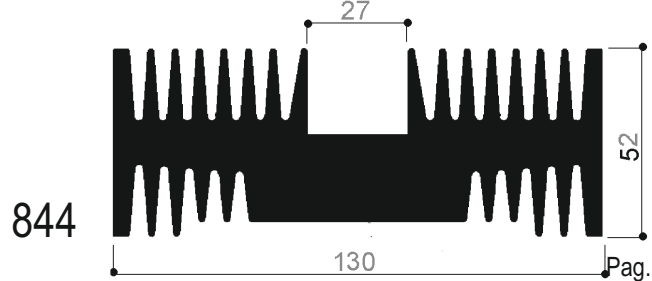
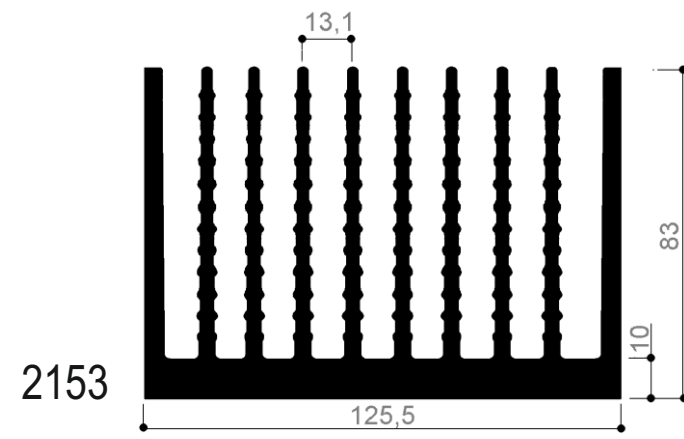
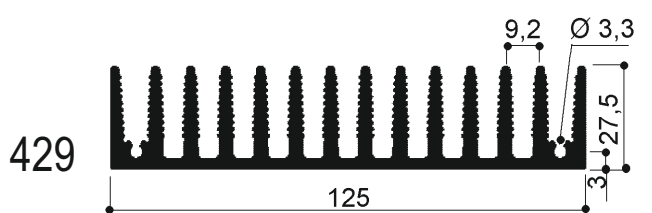
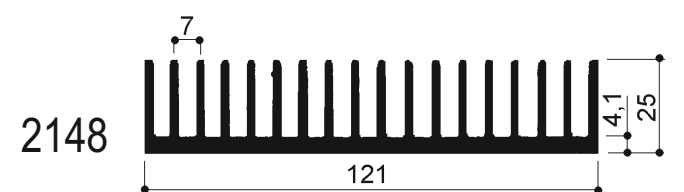
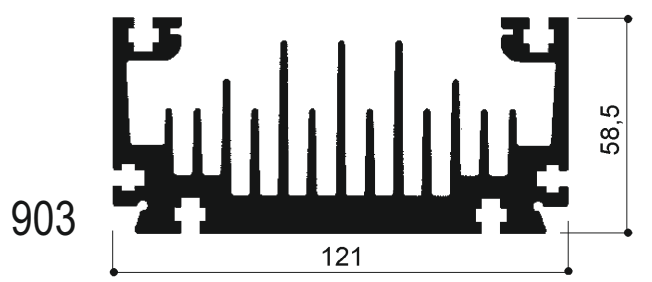
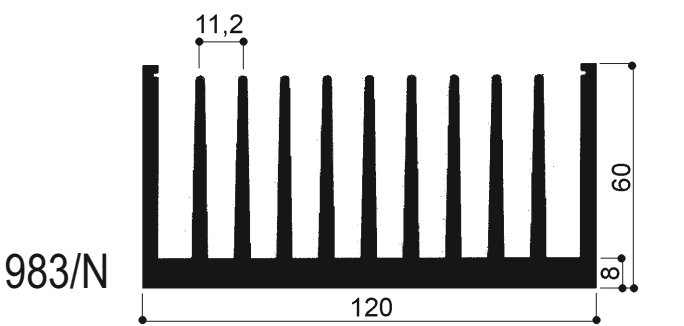
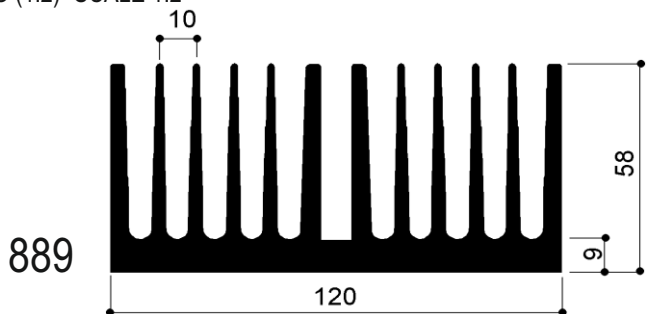
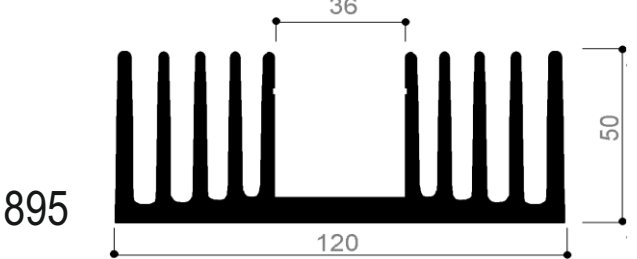
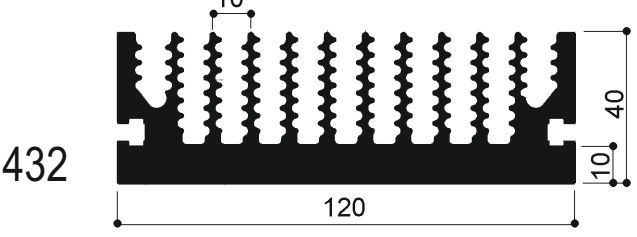
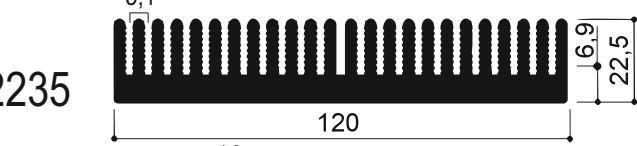
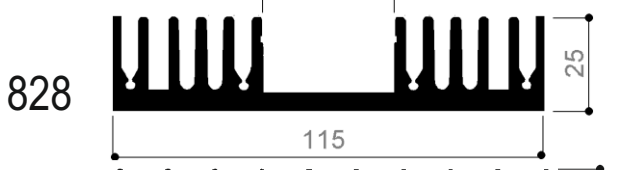
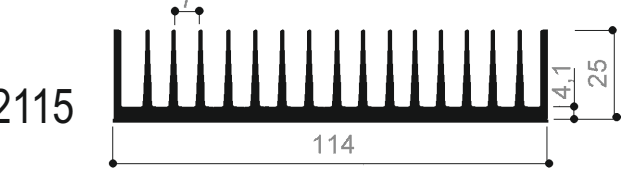
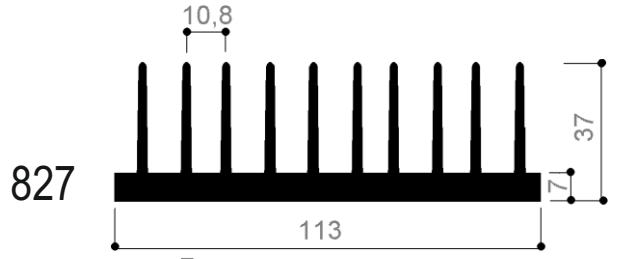
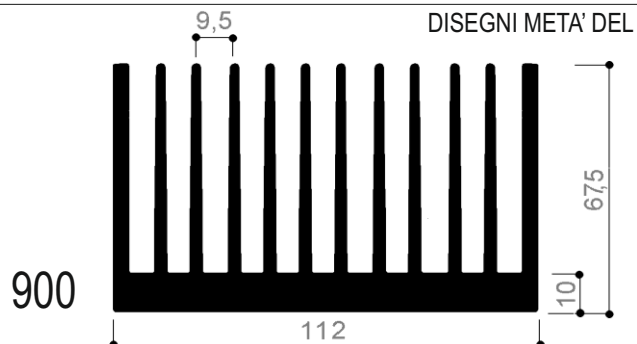

-RIPRODUZIONE VIETATA- AGGIORNAMENTO CONTINUO - ED. DEL 02-2017

Cataloghi Online: www.omar-alluminio.it

www.omar-alluminio.com

PROFILATI ALLUMINIO A DISEGNO / STANDARD / SPECIALI / E PER:

ELETTRONICA / LED / FOTOVOLTAICO / AUTOMAZIONE ROBOTICA / PNEUMATICA / AUTOMOTIVE



Via Newton, n.12

20016 Pero (Milano - Italy)

Tel. +39 02 3535955 r.a. Fax. +39 02 3539929

E-Mail: info@omar-alluminio.it

DISEGNI META' DEL VERO (1:2)- SCALE 1:2

Via Newton, n.12

20016 Pero (Milano - Italy)

Tel. +39 02 3535955 r.a. Fax +39 02 3539929

E-Mail: info@omar-alluminio.it

Cataloghi Online: www.omar-alluminio.it

www.omar-alluminio.com

PROFILATI ALLUMINIO A DISEGNO / STANDARD / SPECIALI / E PER:

ELETTRONICA / LED / FOTOVOLTAICO / AUTOMAZIONE ROBOTICA / PNEUMATICA / AUTOMOTIVE

OMAR s.r.l.
PROFILATI ALLUMINIO
ALTA TECNOLOGIA

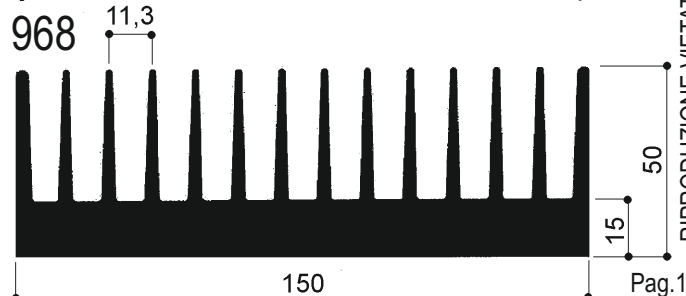
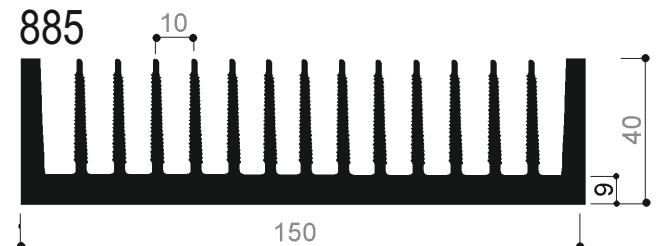
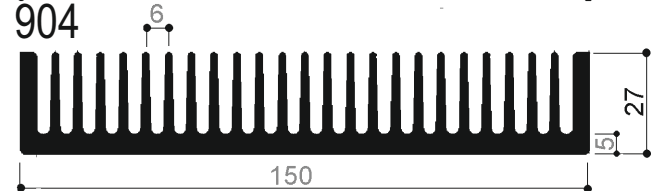
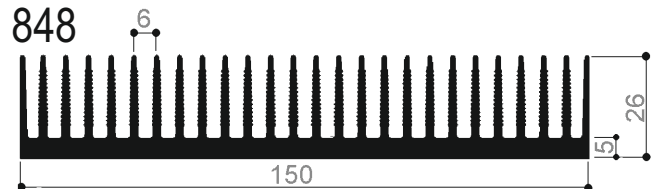
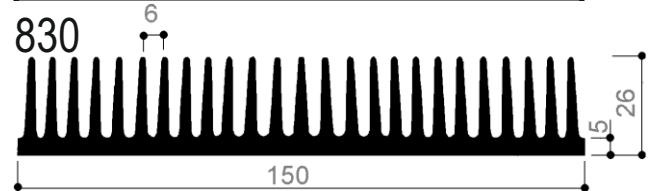
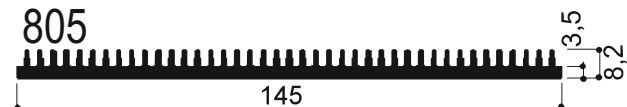
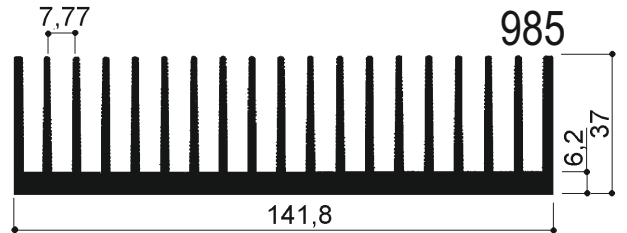
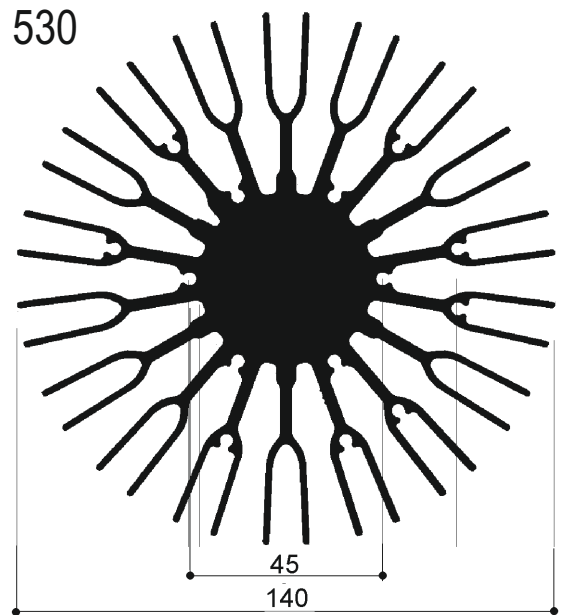
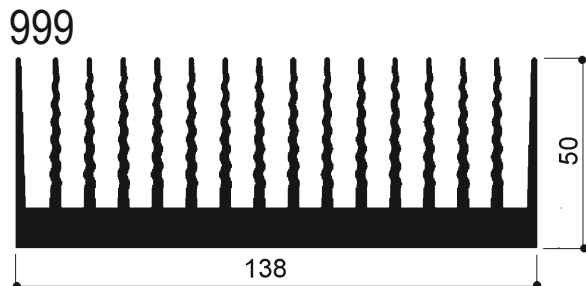
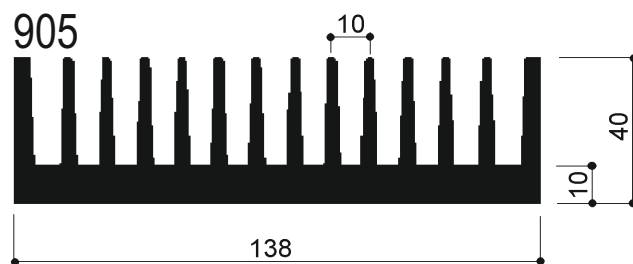
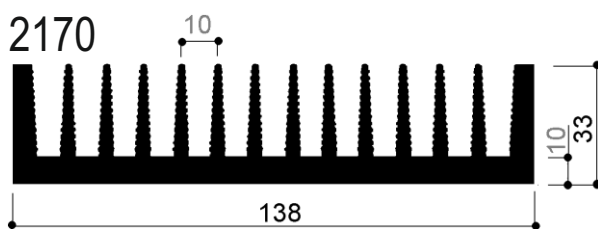
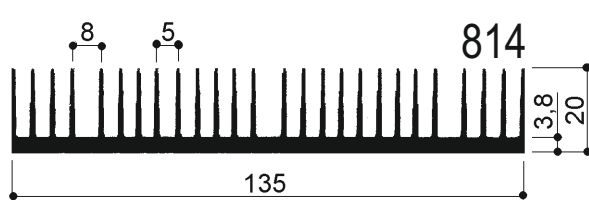
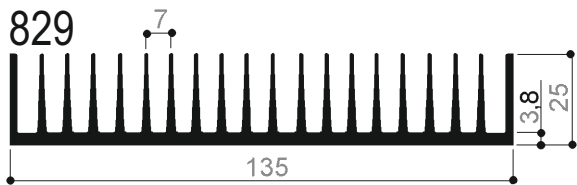
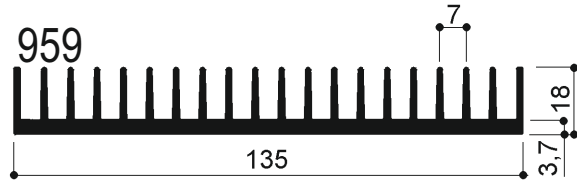
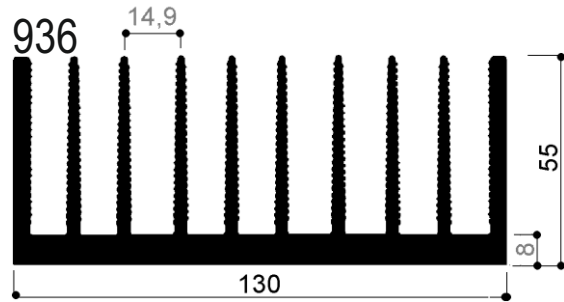
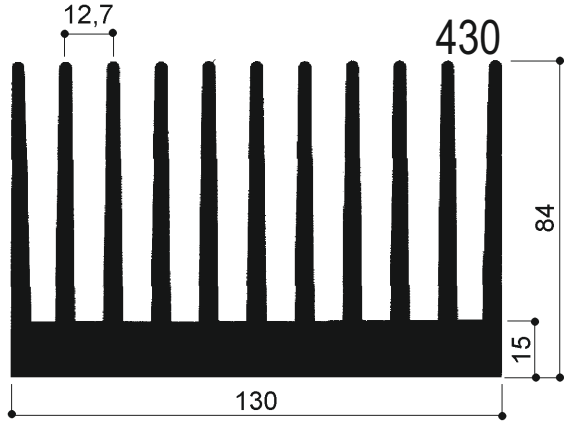

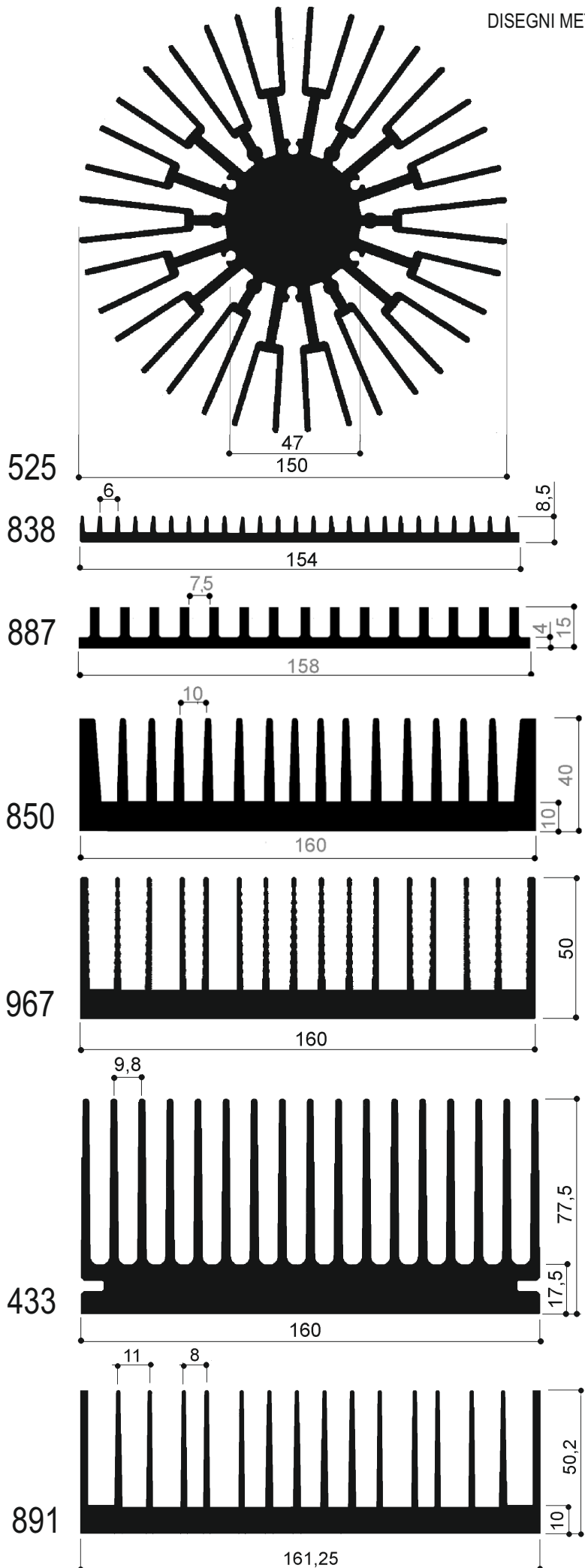

Via Newton, n.12
 20016 Pero (Milano - Italy)
 Tel. +39 02 3535955 r.a. Fax. +39 02 3539929
 E-Mail: info@omar-alluminio.it

Cataloghi Online: www.omar-alluminio.it
www.omar-alluminio.com

PROFILATI ALLUMINIO A DISEGNO / STANDARD / SPECIALI / E PER:
 ELETTRONICA / LED / FOTOVOLTAICO / AUTOMAZIONE ROBOTICA / PNEUMATICA / AUTOMOTIVE



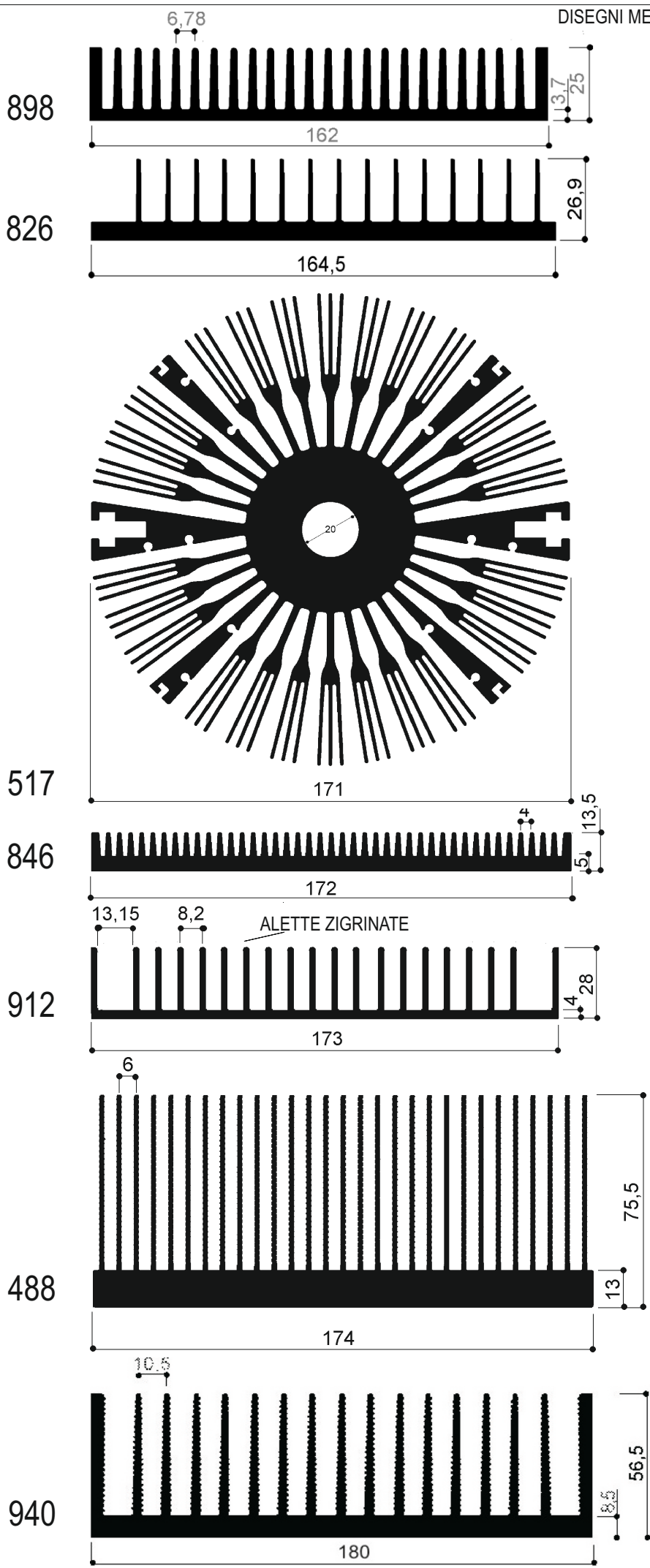

DISEGNI META' DEL VERO (1:2)- SCALE 1:2

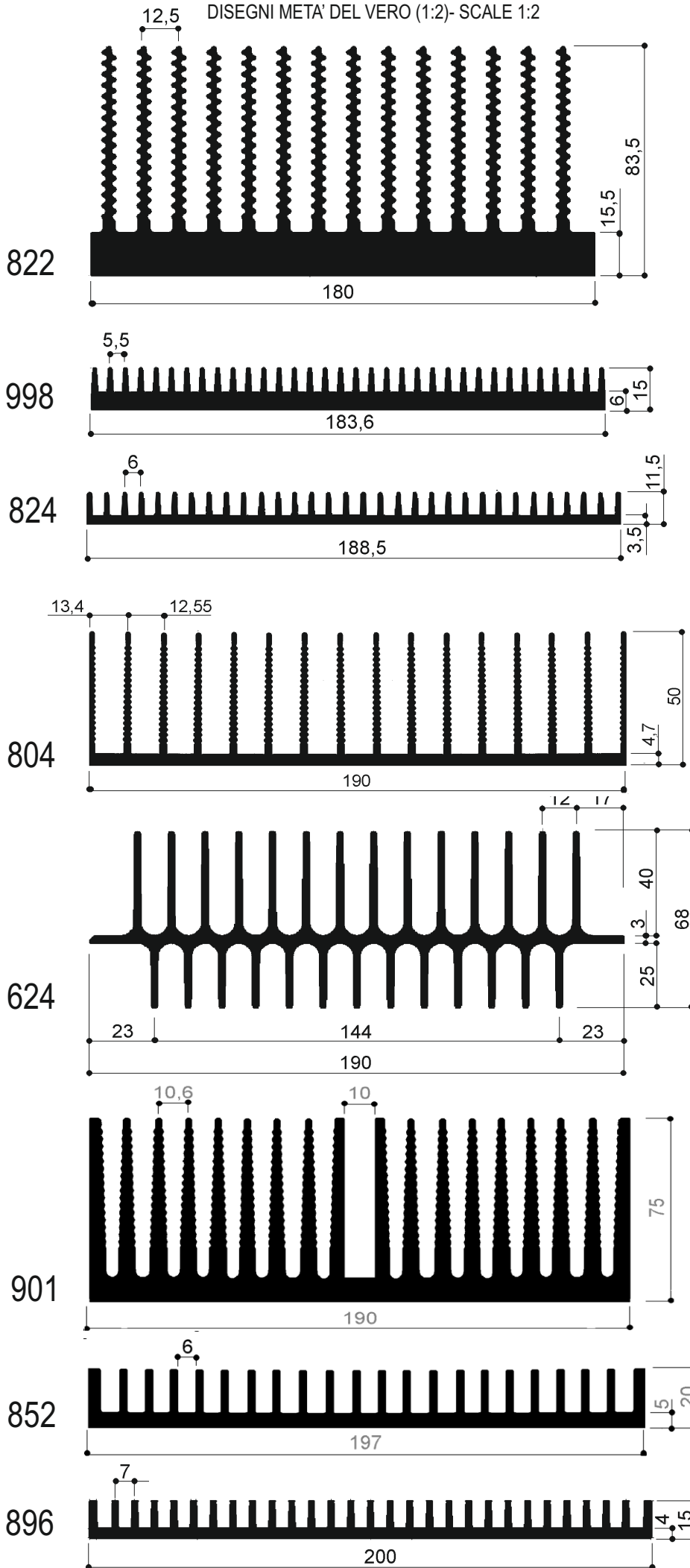

Via Newton, n.12

20016 Pero (Milano - Italy)

Tel. +39 02 3539955 r.a. Fax. +39 02 3539929

E-Mail: info@omar-alluminio.it

Cataloghi Online: www.omar-alluminio.it

www.omar-alluminio.com

PROFILATI ALLUMINIO A DISEGNO / STANDARD / SPECIALI / E PER:

ELETTRONICA / LED / FOTOVOLTAICO / AUTOMAZIONE ROBOTICA / PNEUMATICA / AUTOMOTIVE



Via Newton, n.12
 20016 Pero (Milano - Italy)
 Tel. +39 02 3535955 r.a. Fax. +39 02 3539929
 E.Mai: info@omar-alluminio.it

Cataloghi Online: www.omar-alluminio.it
 www.omar-alluminio.com

PROFILATI ALLUMINIO A DISEGNO / STANDARD / SPECIALI / E PER:
 ELETTRONICA / LED / FOTOVOLTAICO / AUTOMAZIONE ROBOTICA / PNEUMATICA / AUTOMOTIVE

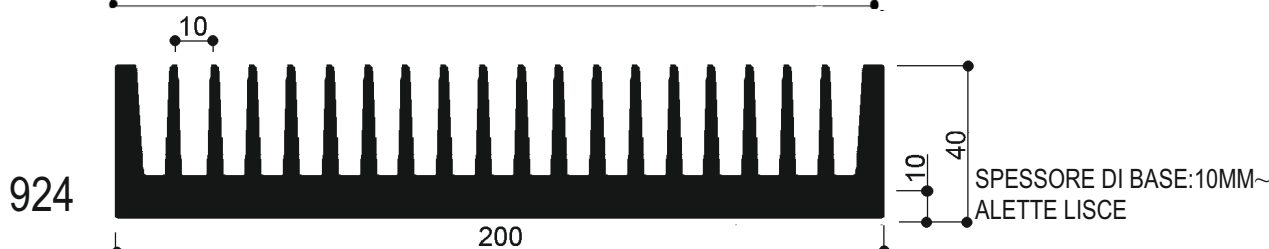
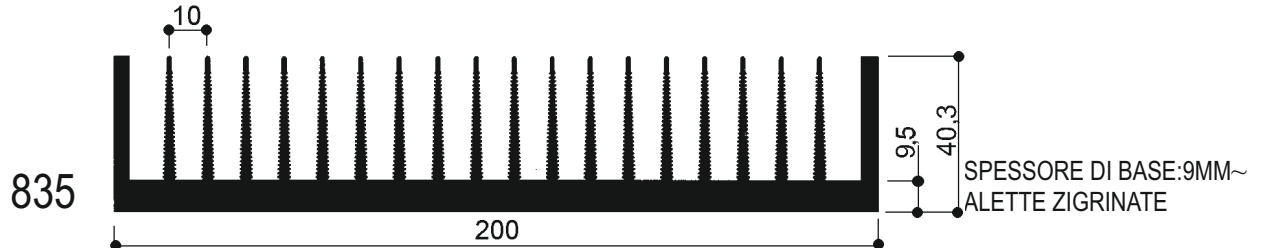
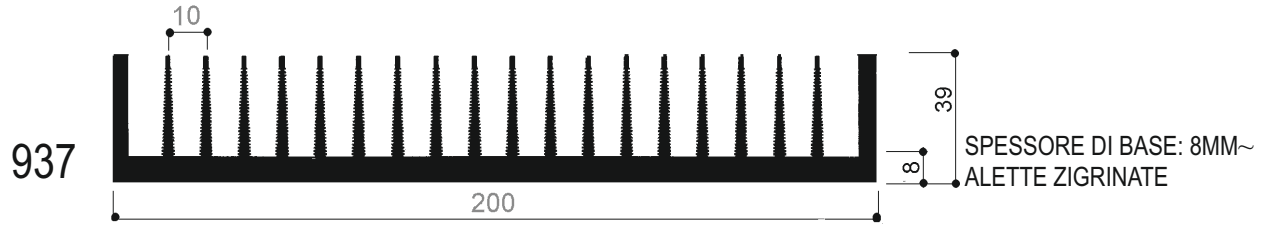
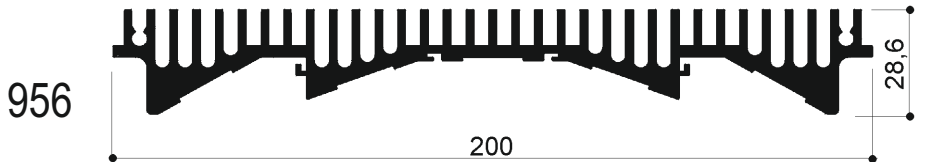
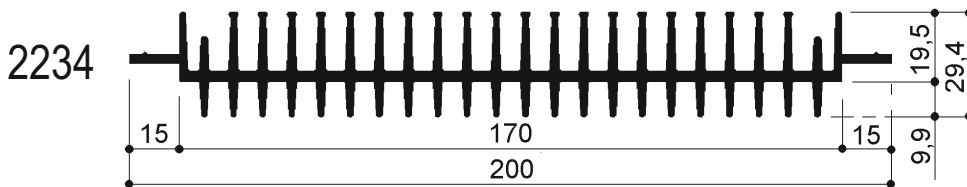
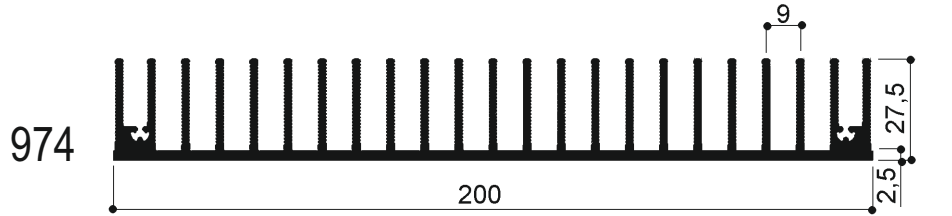
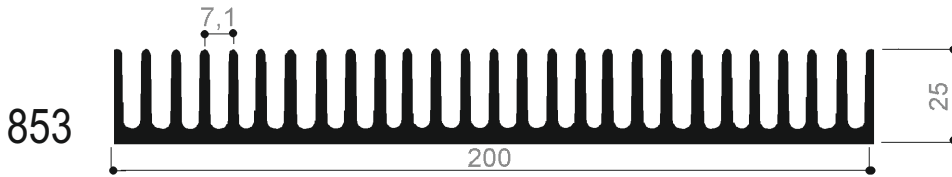
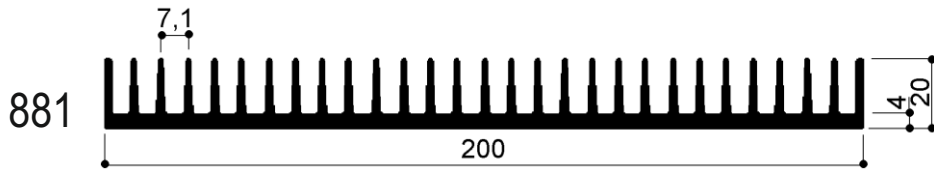

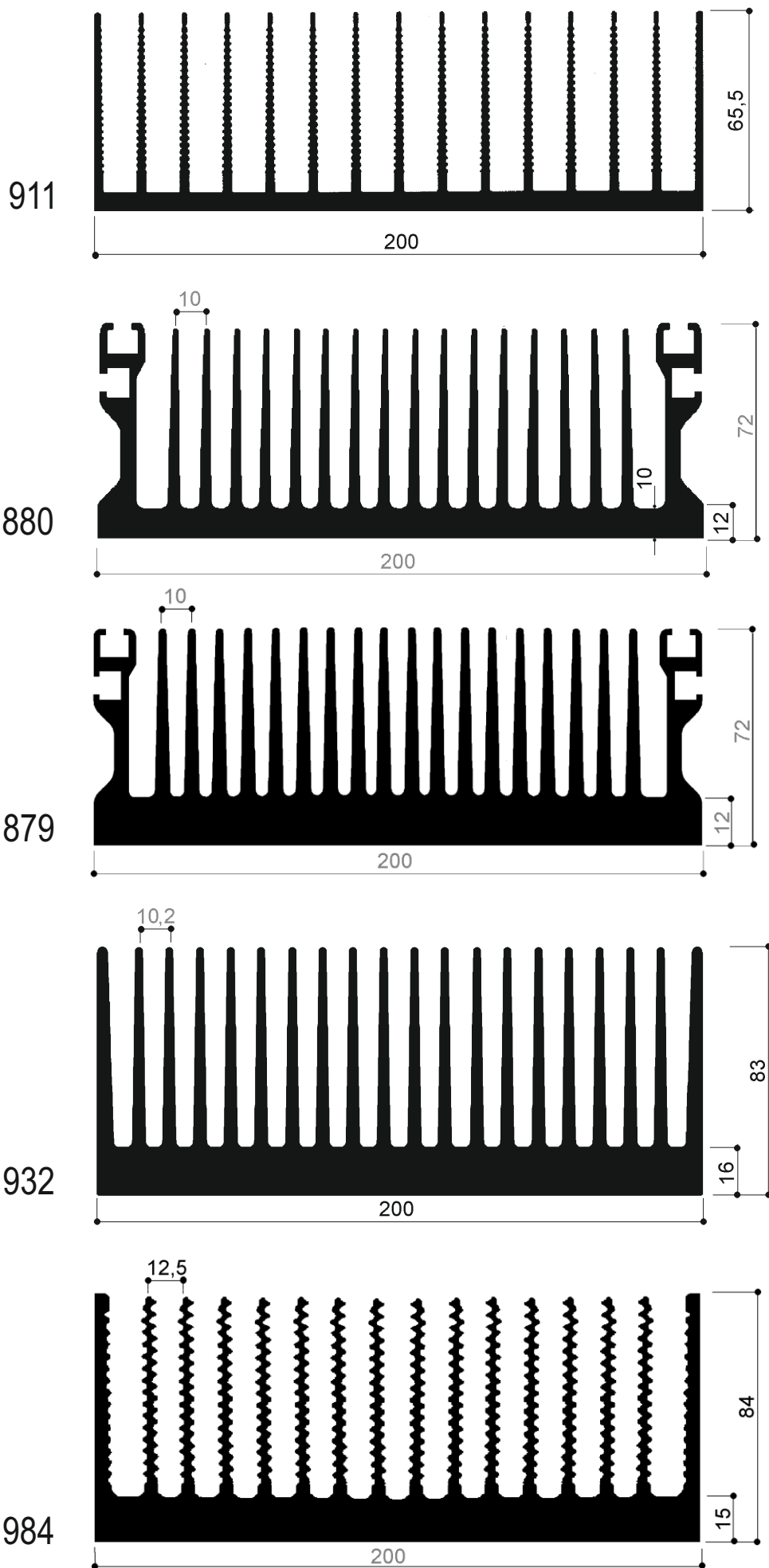

Via Newton, n.12
 20016 Pero (Milano - Italy)
 Tel. +39 02 3535955 r.a. Fax. +39 02 3539929
 E-Mail: info@omar-alluminio.it

Cataloghi Online: www.omar-alluminio.it
www.omar-alluminio.com

PROFILATI ALLUMINIO A DISEGNO / STANDARD / SPECIALI / E PER:

ELETTRONICA / LED / FOTOVOLTAICO / AUTOMAZIONE ROBOTICA / PNEUMATICA / AUTOMOTIVE



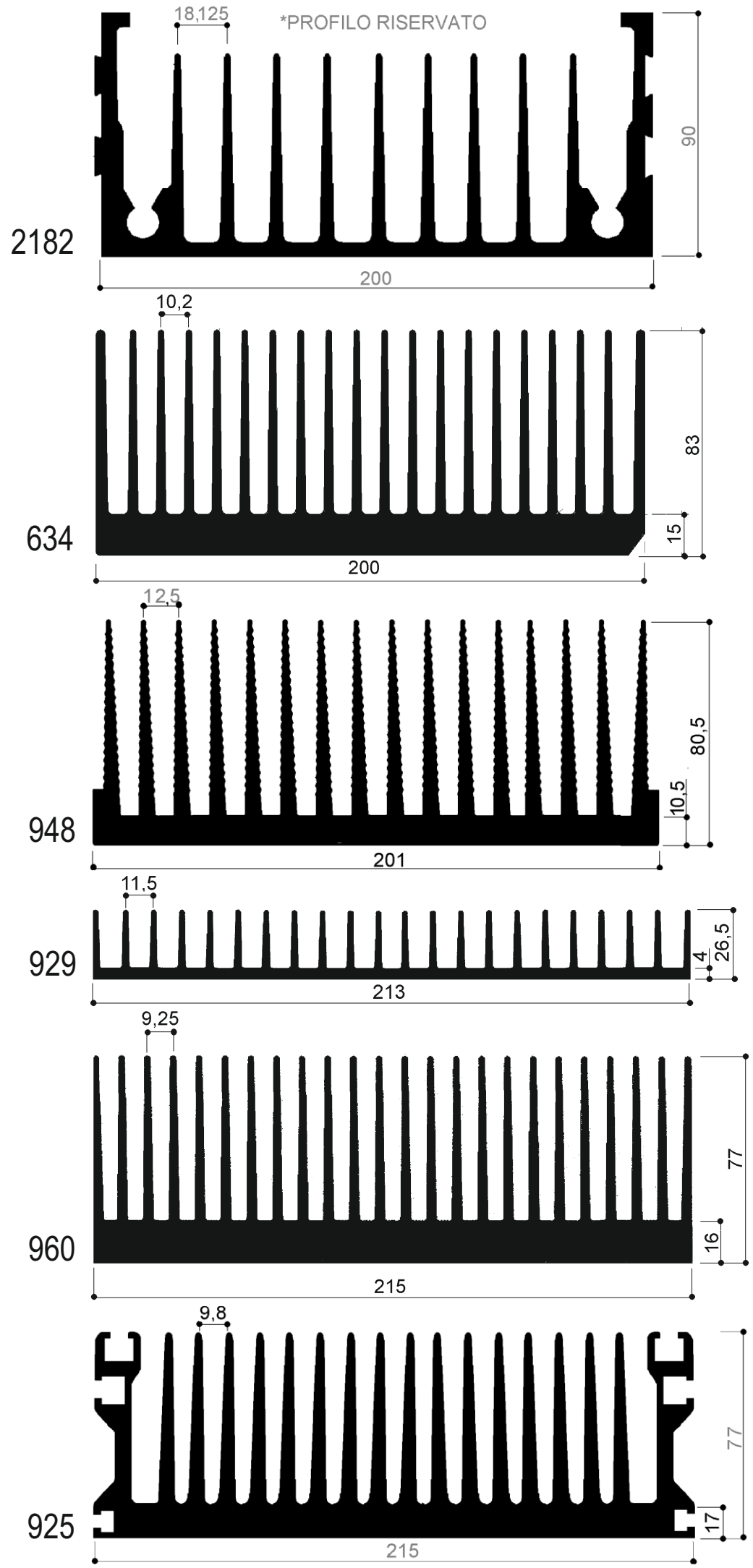

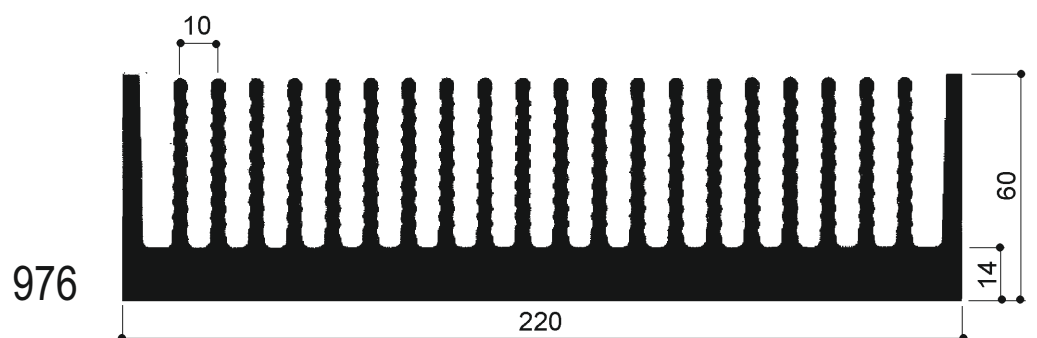
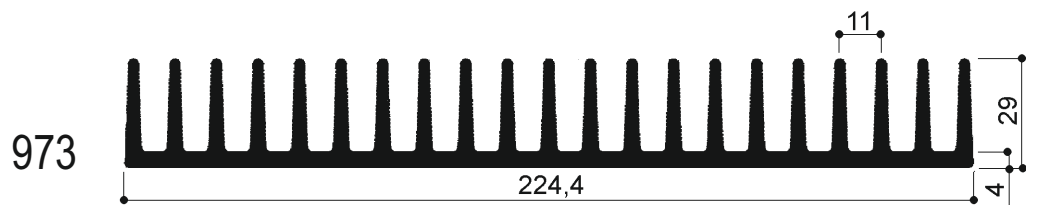
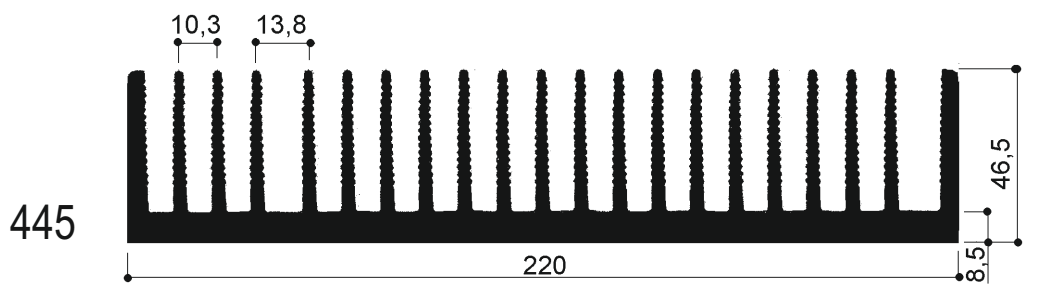
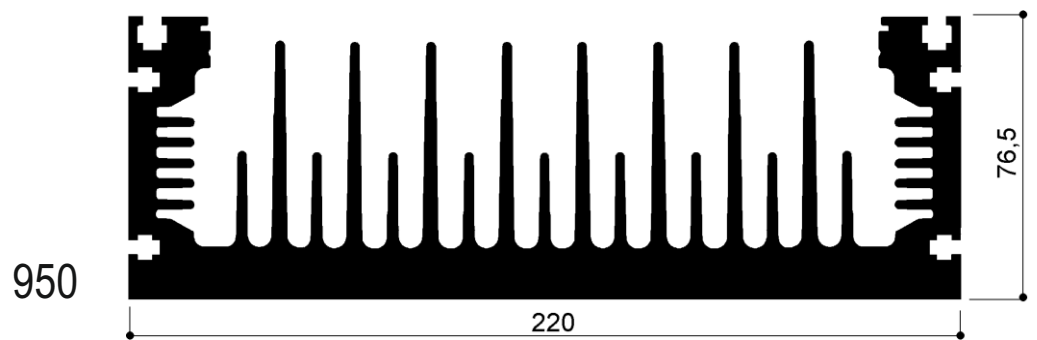
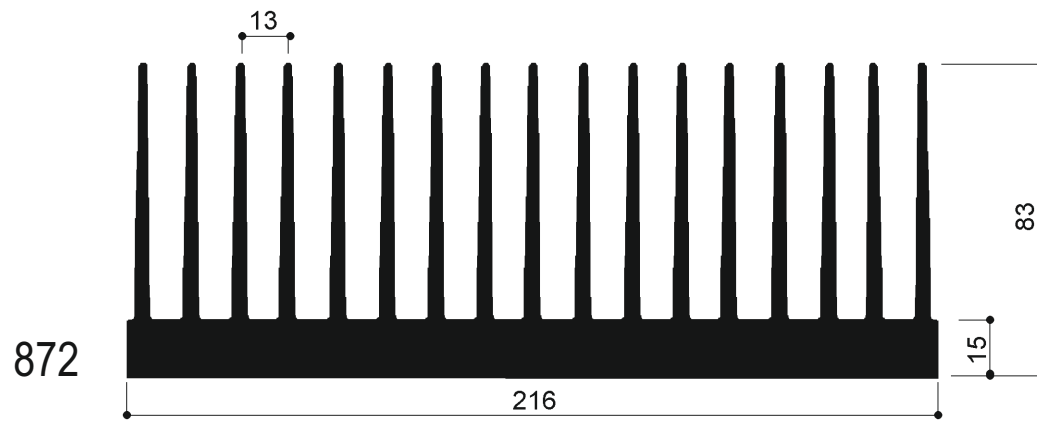
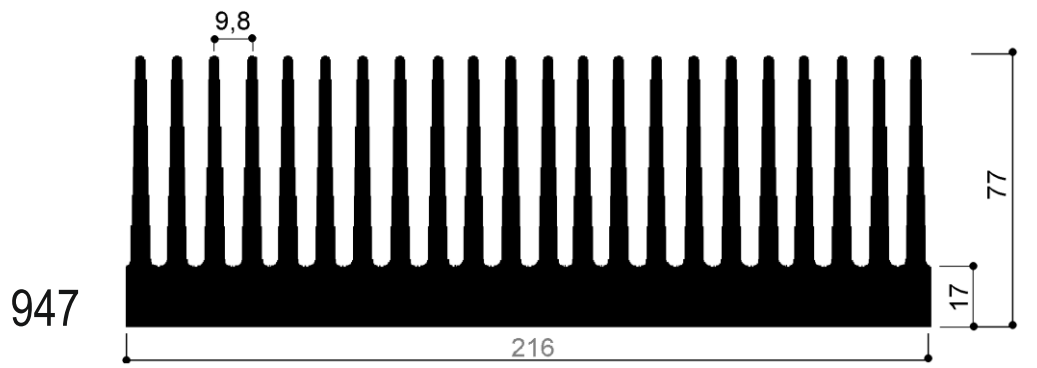

DISEGNI META' DEL VERO (1:2)- SCALE 1:2

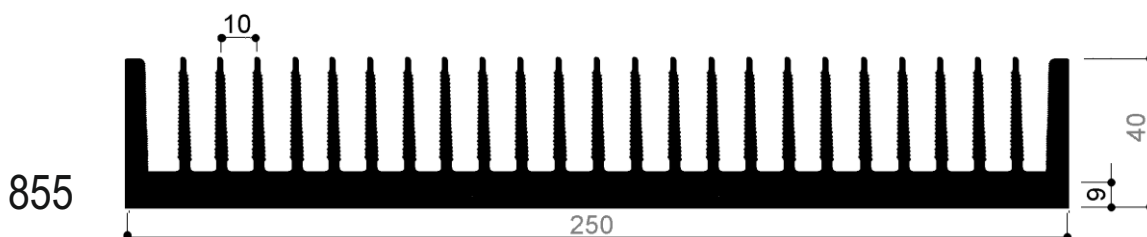
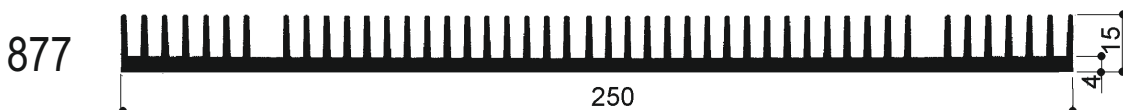
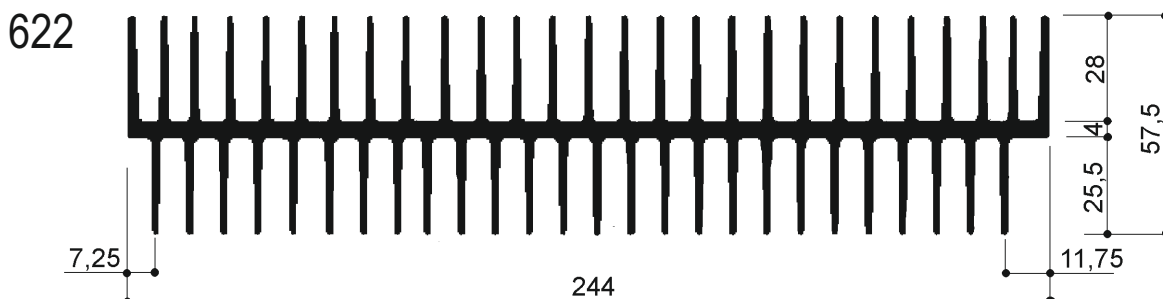
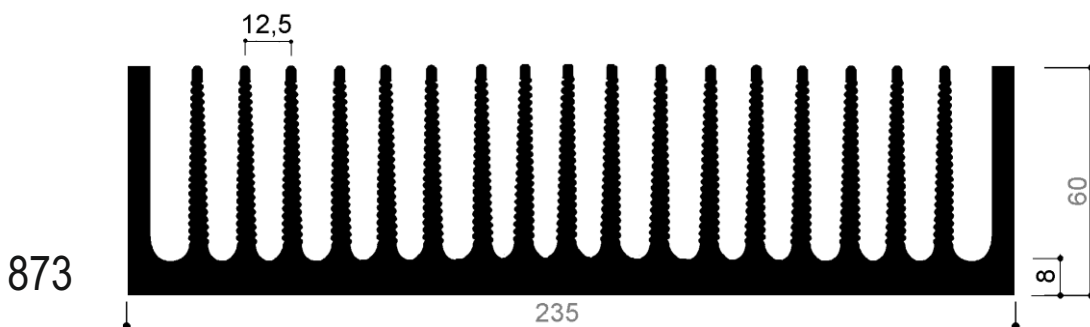
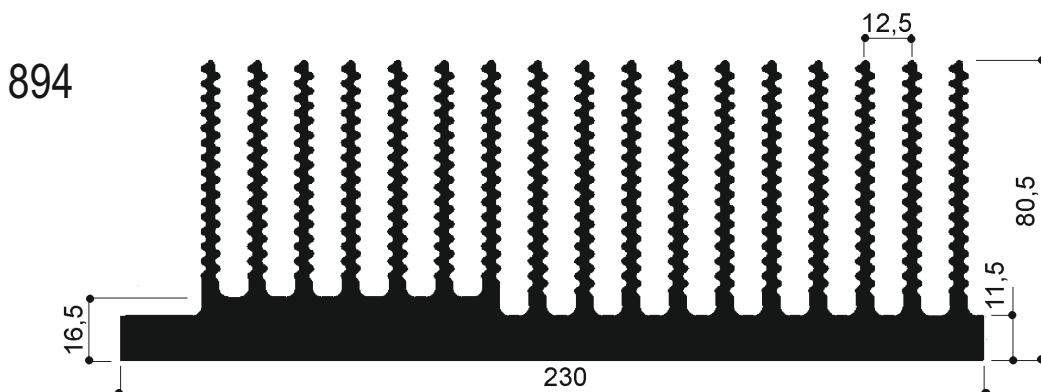
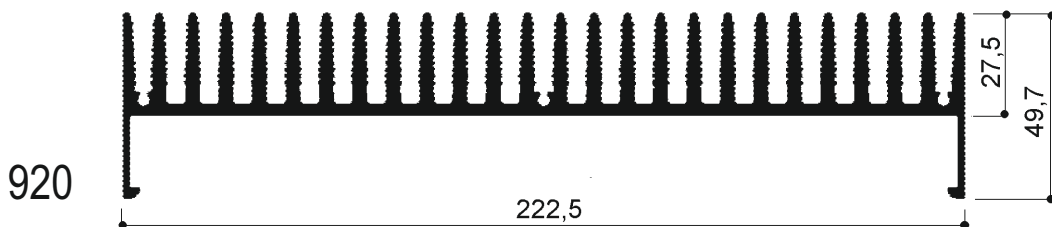

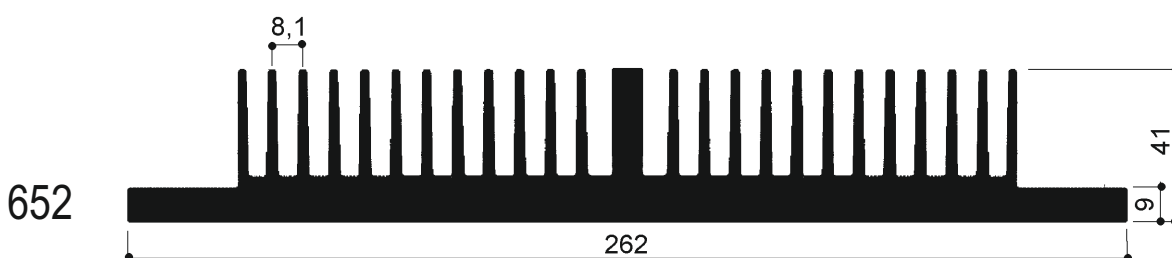
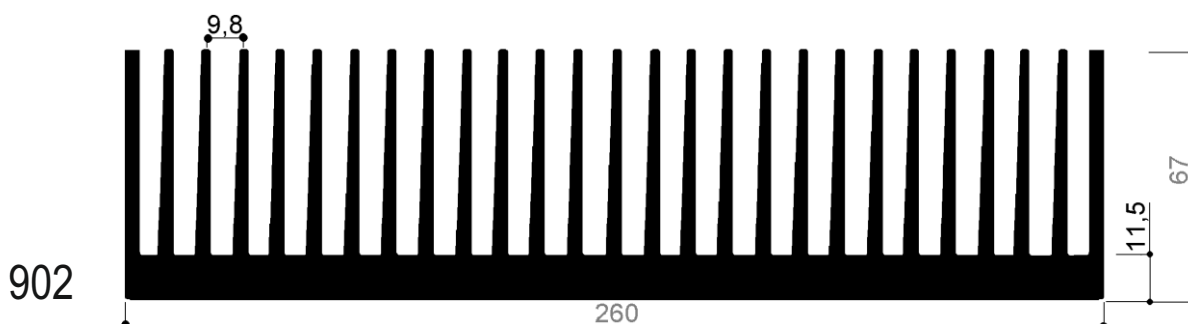
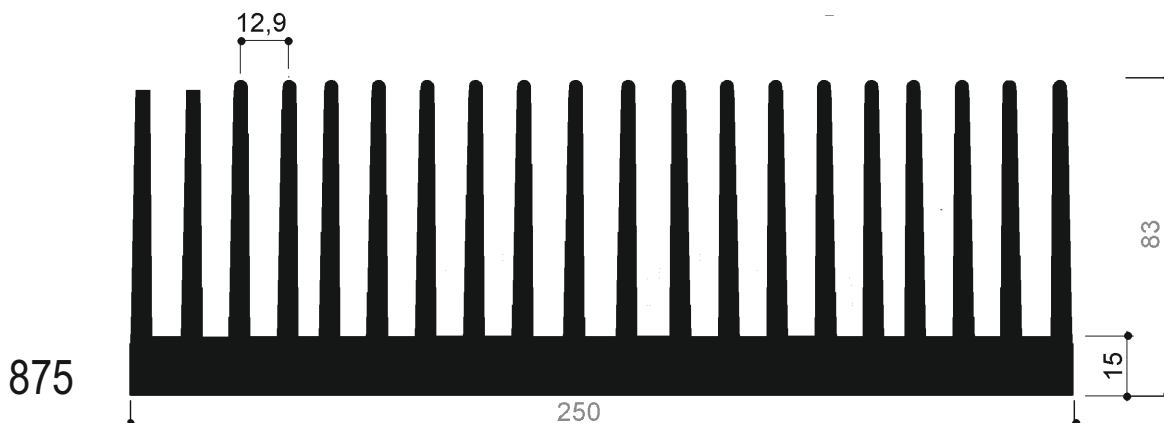
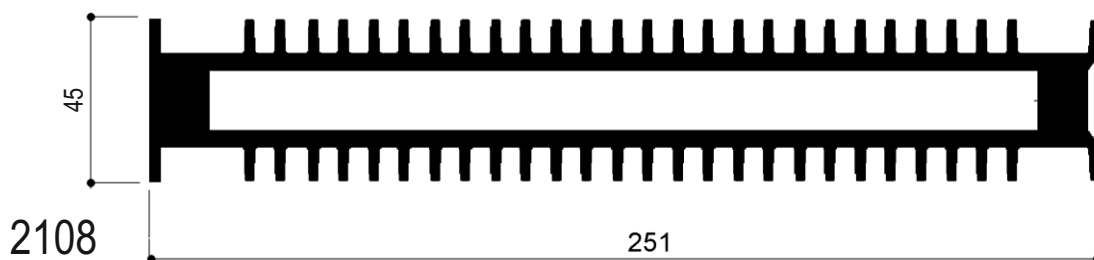
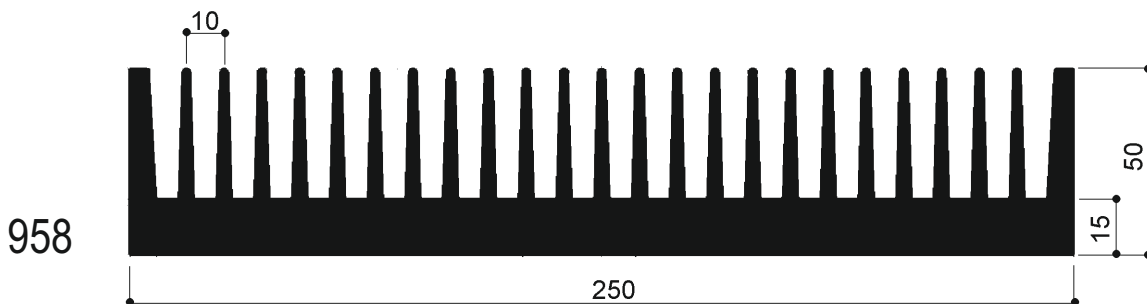
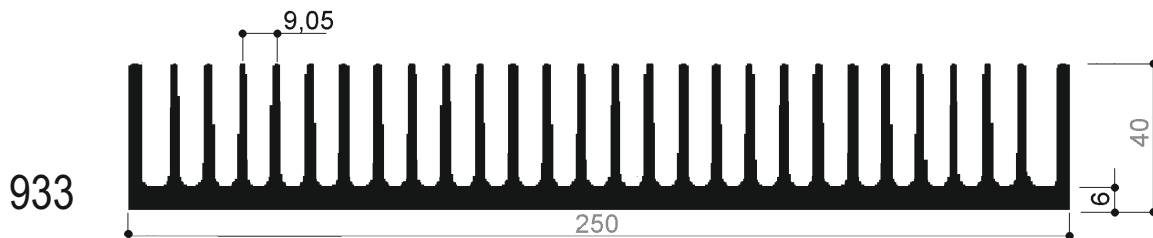

Cataloghi Online: www.omar-alluminio.it
www.omar-alluminio.com

PROFILATI ALLUMINIO A DISEGNO / STANDARD / SPECIALI / E PER:

ELETTRONICA / LED / FOTOVOLTAICO / AUTOMAZIONE ROBOTICA / PNEUMATICA / AUTOMOTIVE

Via Newton, n.12
 20016 Pero (Milano - Italy)
 Tel. +39 02 3535955 r.a. Fax. +39 02 3539929
 E-Mail: info@omar-alluminio.it



DISEGNI META' DEL VERO (1:2)- SCALE 1:2

Via Newton, n.12
20016 Pero (Milano - Italy)
Tel. +39 02 3535955 r.a. Fax. +39 02 3539929
E.Mai: info@omar-alluminio.it

Cataloghi Online: www.omar-alluminio.it
www.omar-alluminio.com

PROFILATI ALLUMINIO A DISEGNO / STANDARD / SPECIALI / E PER:

ELETTRONICA / LED / FOTOVOLTAICO / AUTOMAZIONE ROBOTICA / PNEUMATICA / AUTOMOTIVE

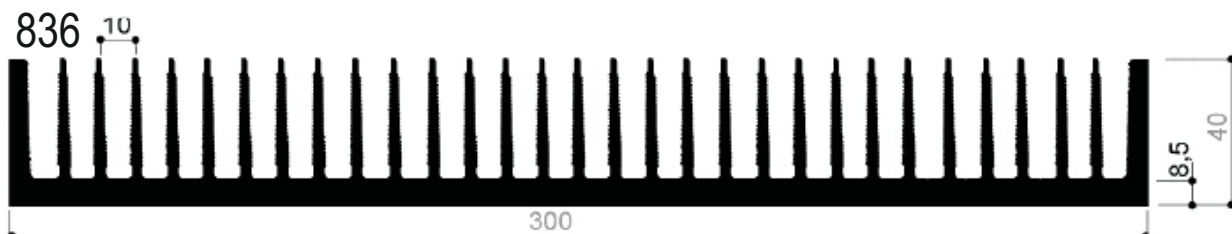
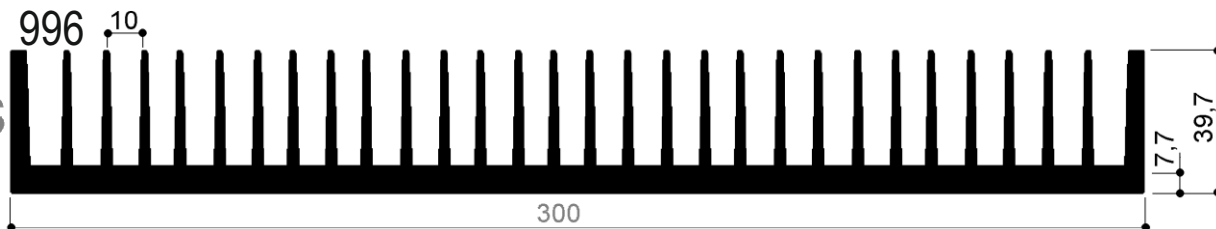
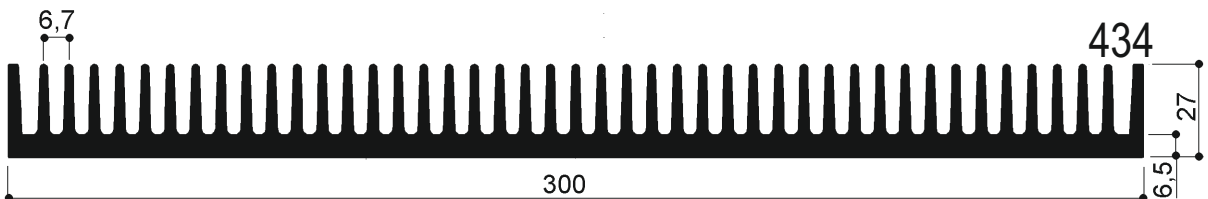
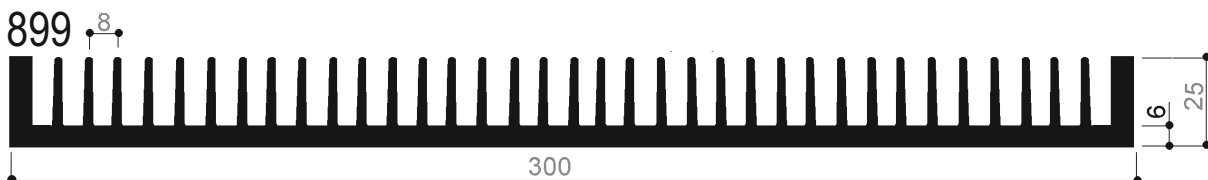
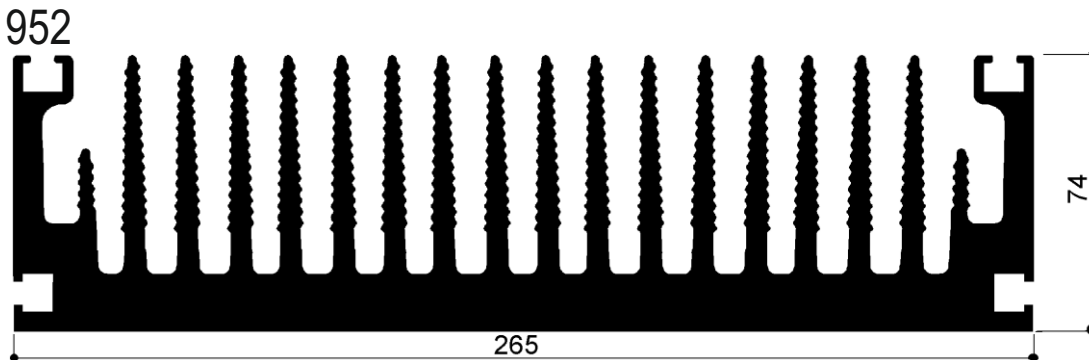
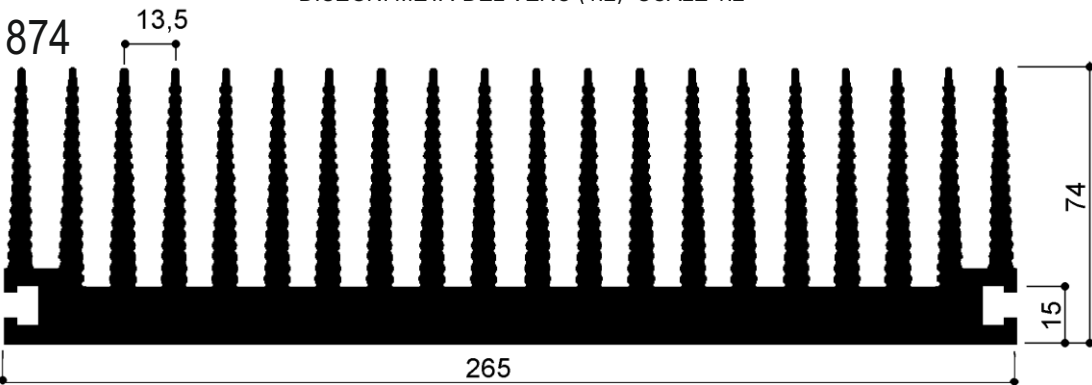

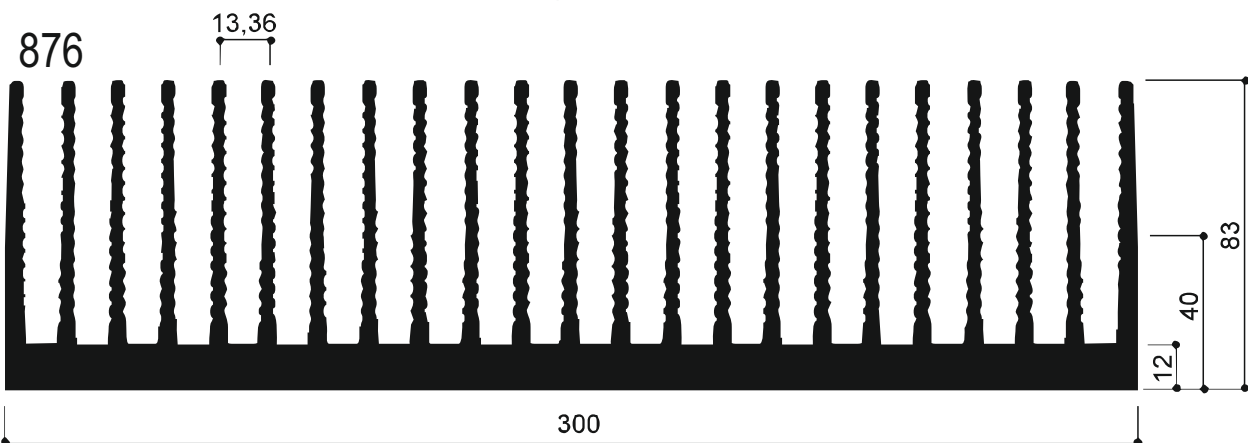
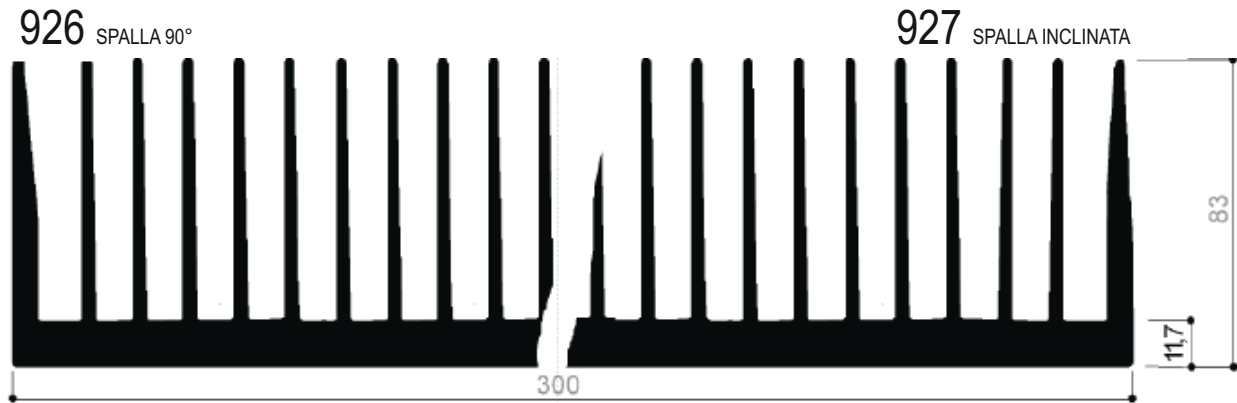
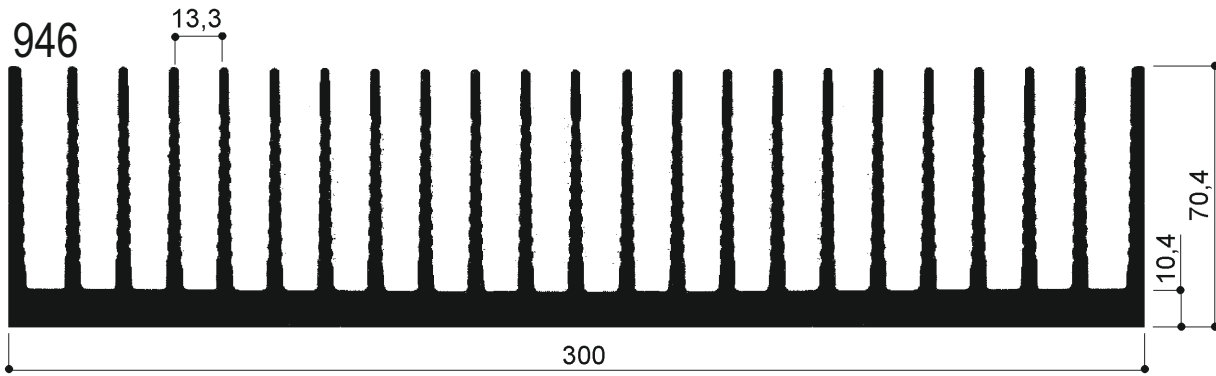
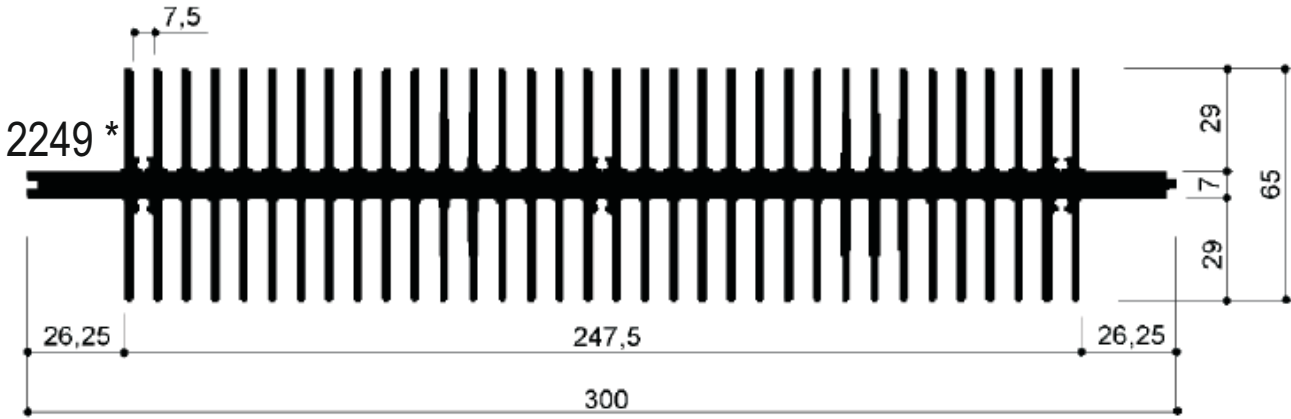
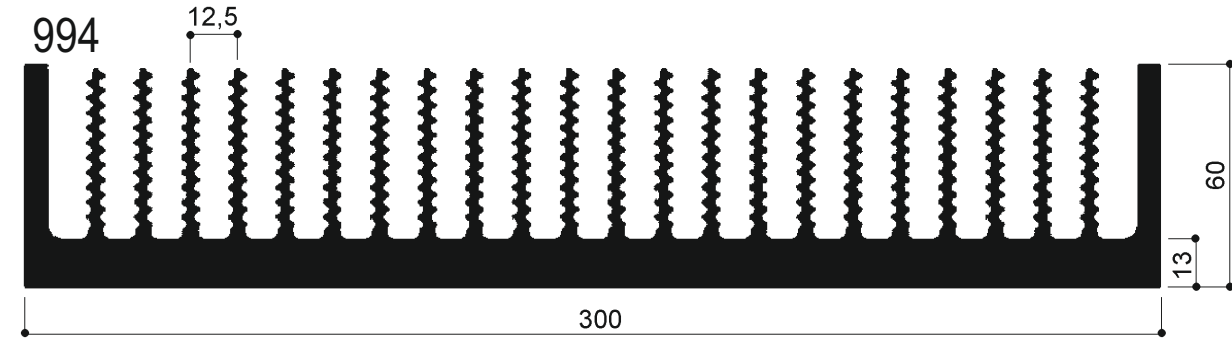

Cataloghi Online: www.omar-alluminio.it

www.omar-alluminio.com

PROFILATI ALLUMINIO A DISEGNO / STANDARD / SPECIALI / E PER:

ELETTRONICA / LED / FOTOVOLTAICO / AUTOMAZIONE ROBOTICA / PNEUMATICA / AUTOMOTIVE

Via Newton, n.12

20016 Pero (Milano - Italy)

Tel. +39 02 3535955 r.a. Fax. +39 02 3539929

E-Mail: info@omar-alluminio.it



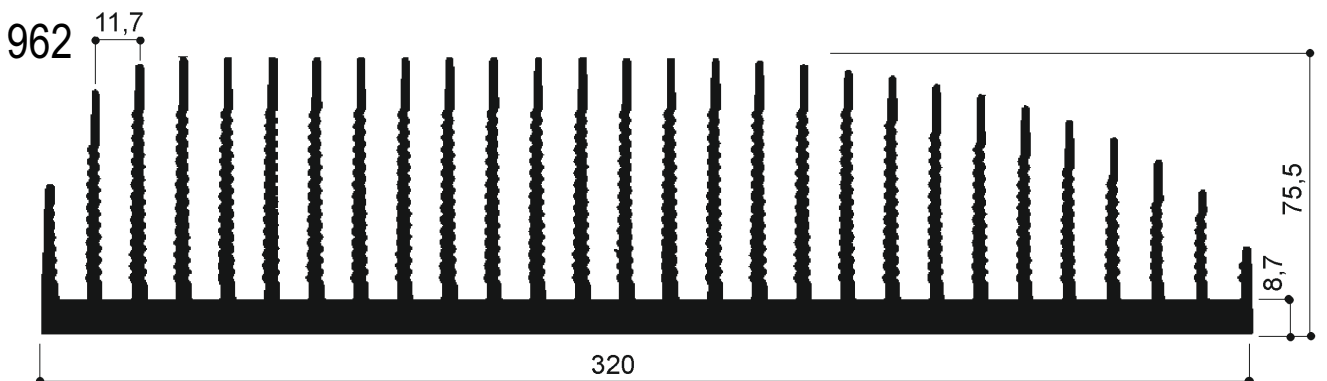
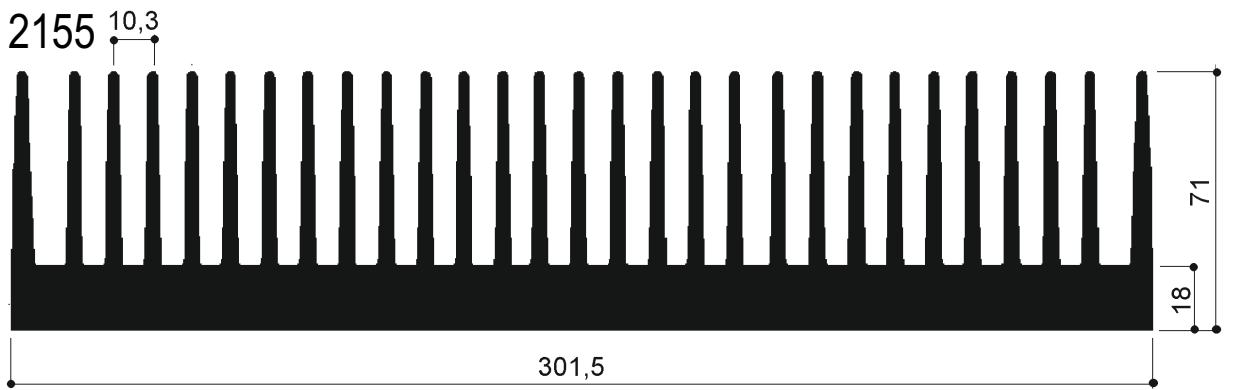
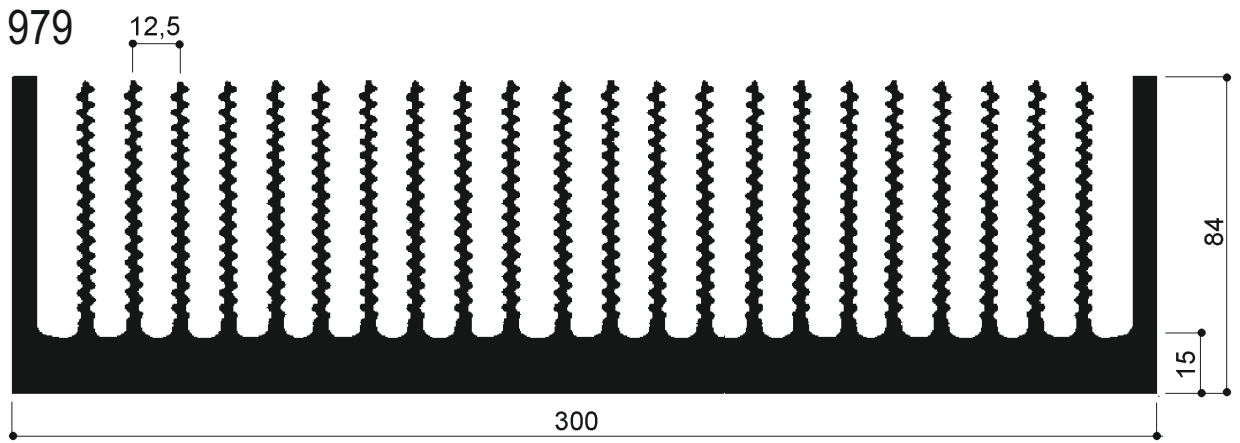
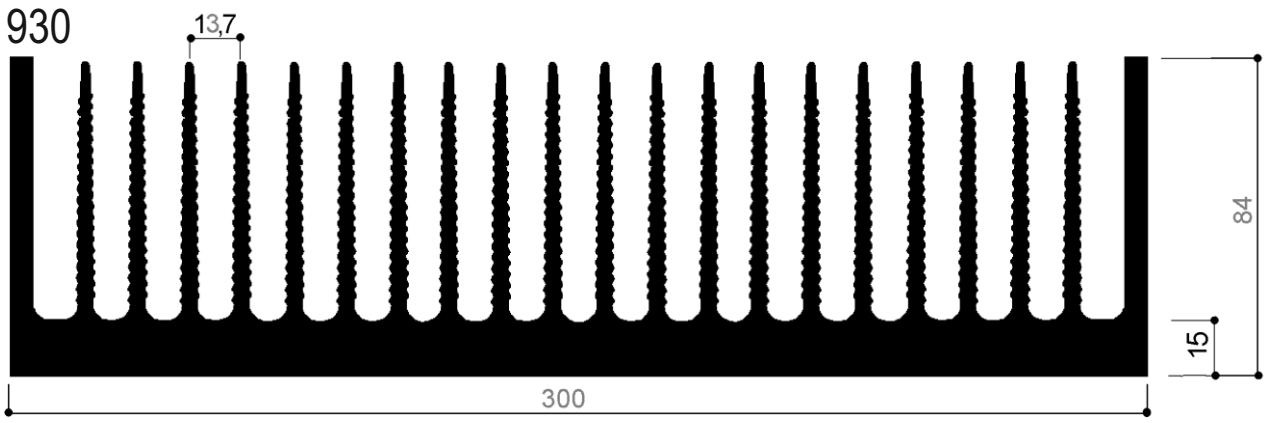

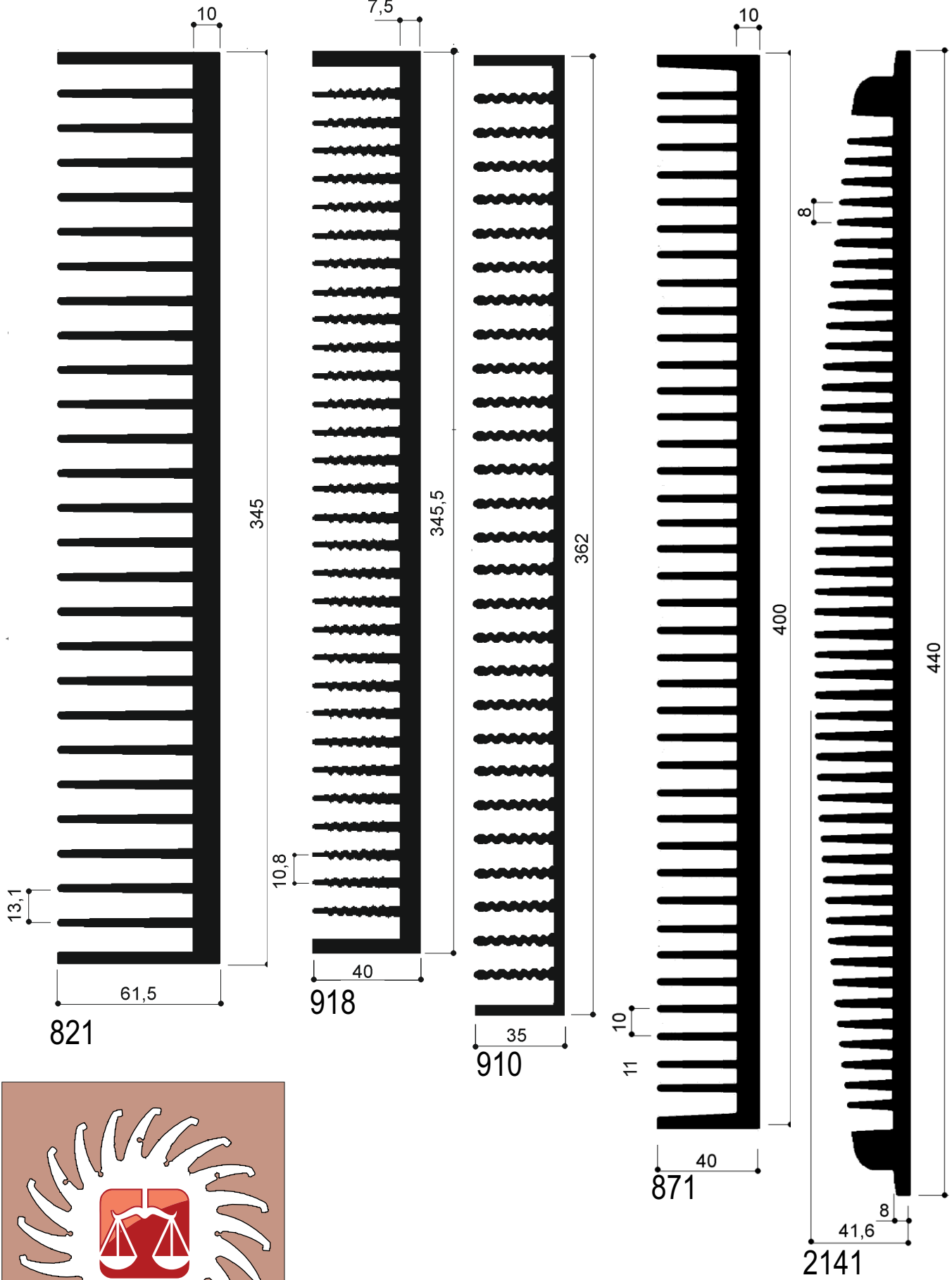

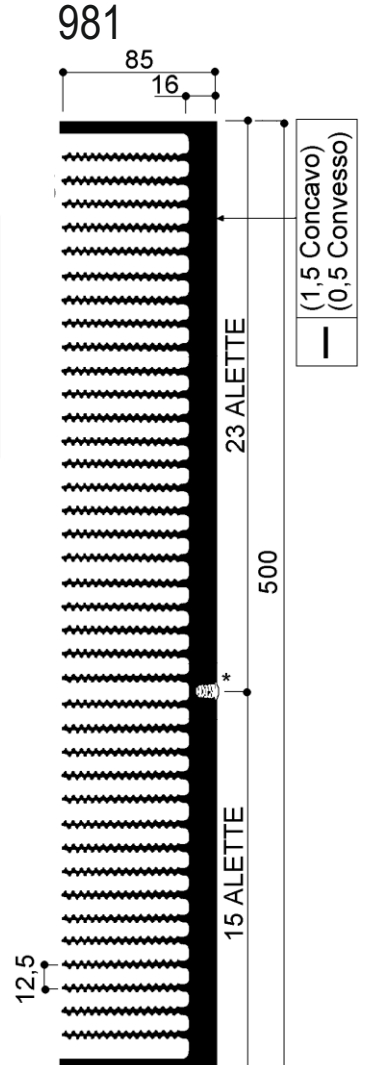
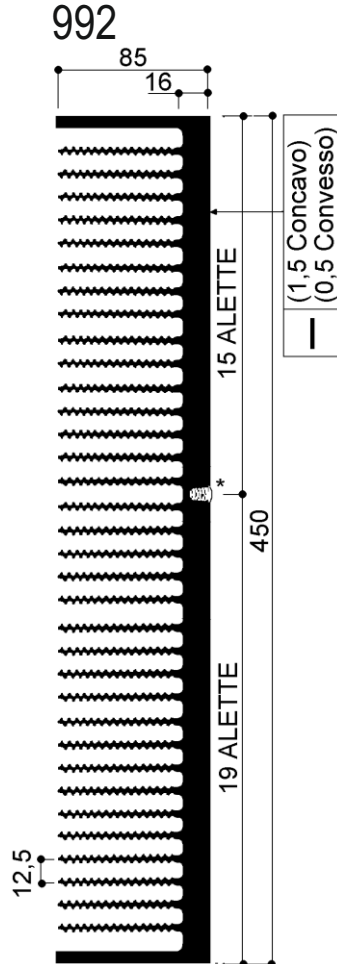
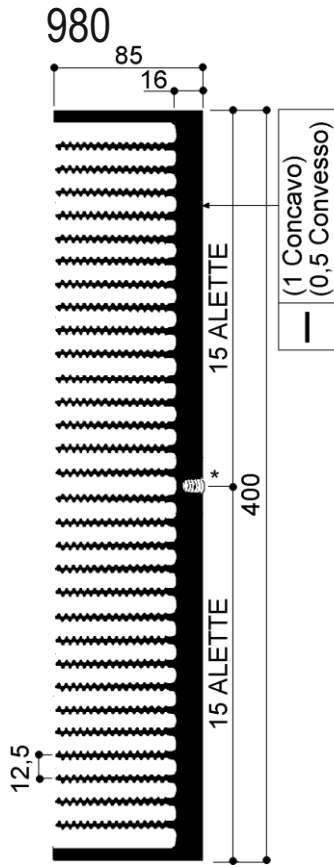
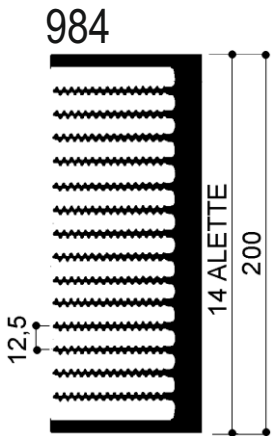
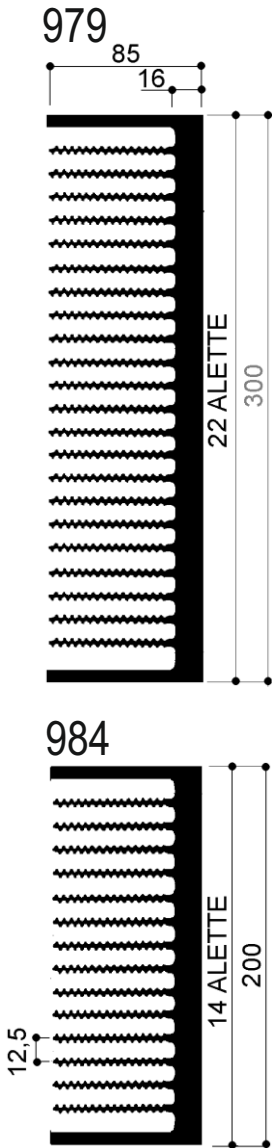
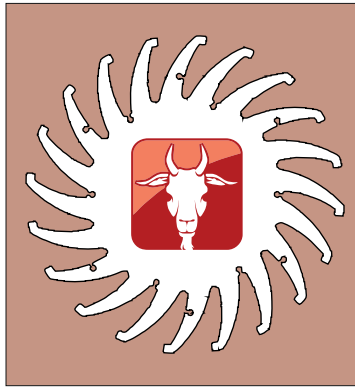

SALDATURA IN ACCORDO ALLA NORMA EN288-4:1992 / A1:1997
 WELDING PROCESS ACCORDING TO EN288-4:1992 / A1:1997
 *CORDONE DI SALDATURA - WELDING WIRE

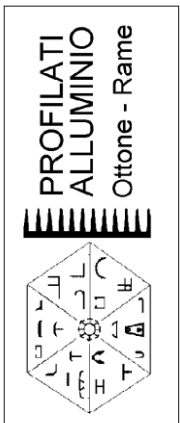

OLTRE AI PROFILI RIPORTATI A CATALOGO PRONTI A MAGAZZINO SIAMO IN GRADO DI FORNIRE DISSIPATORI IN BARRE CON SAGOME 'CUSTOM' ANCHE PER MODESTI QUANTITATIVI.

TUTTI I PROFILI SONO FORNIBILI NEI SEGUENTI FORMATI:

- BARRE DA 3 / 4 METRI
- TAGLIATI A MISURA (GREZZI/OSSIDATI)
- COMPLETAMENTE LAVORATO SECONDO VS. DISEGNO

WE ARE ABLE TO SUPPLY:

- CUSTOM SECTIONS ALSO FOR LITTLE QUANTITY
- CUSTOM DRILLINGS

FOTO DI ESEMPIO:
DISSIPATORI TONDI RICAUVATI
DA BARRA MEDIANTE
FRESATURA

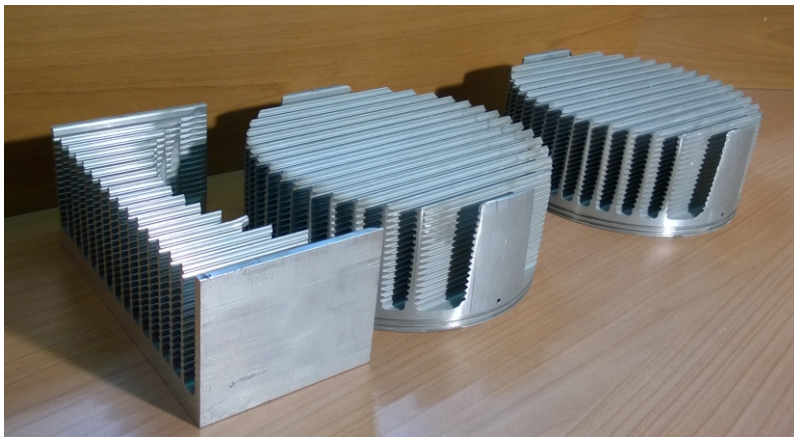

SALDATURA IN ACCORDO ALLA NORMA EN288-4:1992 / A1:1997
WELDING PROCESS ACCORDING TO EN288-4:1992 / A1:1997
*CORDONE DI SALDATURA - WELDING WIRE

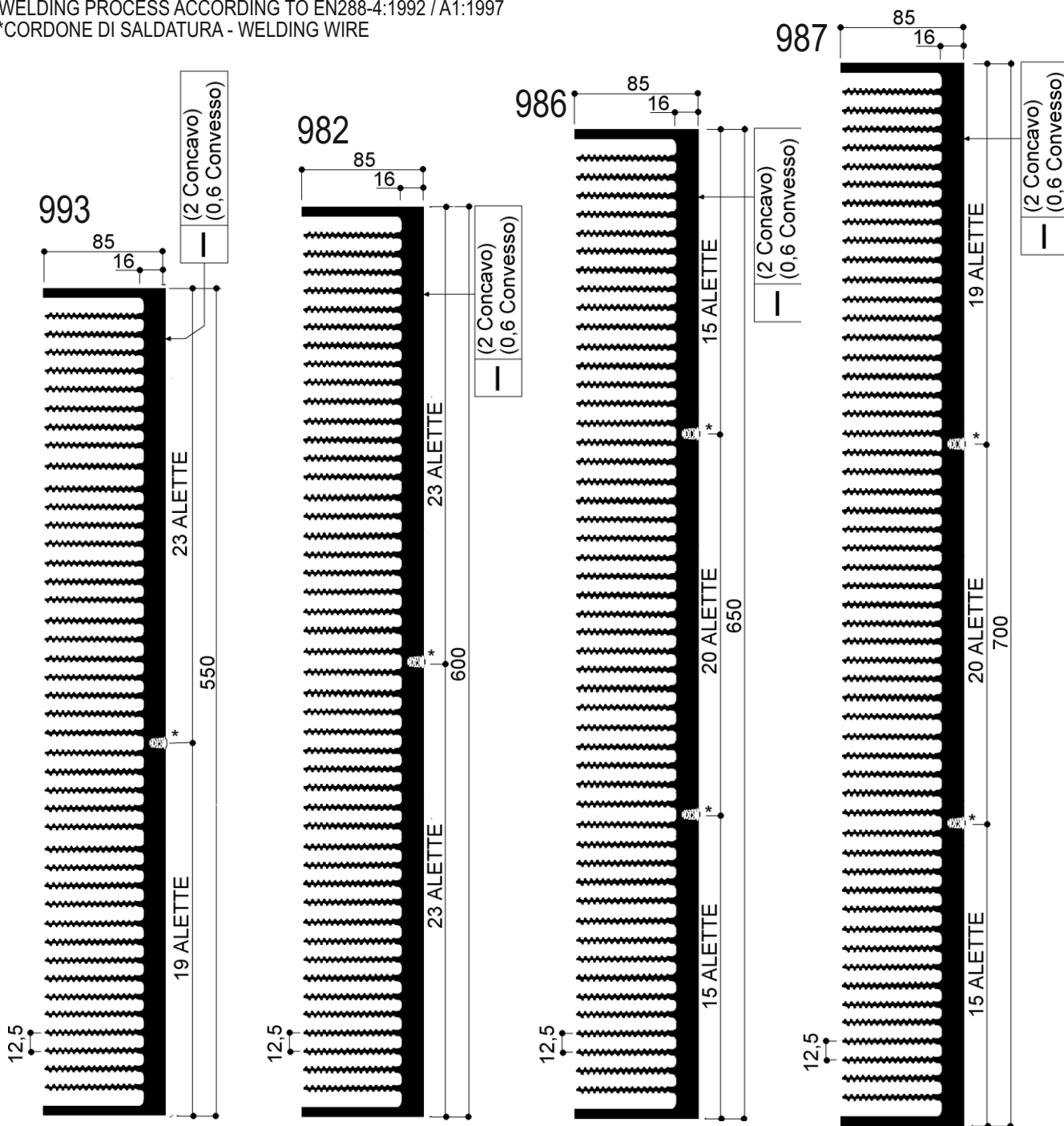

Cataloghi Online: www.omar-alluminio.it
www.omar-alluminio.com

PROFILATI ALLUMINIO A DISEGNO / STANDARD / SPECIALI / E PER:
ELETTRONICA / LED / FOTOVOLTAICO / AUTOMAZIONE ROBOTICA / PNEUMATICA / AUTOMOTIVE



Via Newton, n.12
20016 Pero (Milano - Italy)
Tel. +39 02 3535955 r.a. Fax. +39 02 3539929
E-Mail: info@omar-alluminio.it

SALDATURA SECONDO NORME EN288-4:1992 / A1:1997
 WELDING PROCESS ACCORDING TO EN288-4:1992 / A1:1997

*CORDONE DI SALDATURA - WELDING WIRE

Cataloghi Online: www.omar-alluminio.it
www.omar-alluminio.com

PROFILATI ALLUMINIO A DISEGNO / STANDARD / SPECIALI / E PER:

ELETTRONICA / LED / FOTOVOLTAICO / AUTOMAZIONE ROBOTICA / PNEUMATICA / AUTOMOTIVE

Via Newton, n.12
 20016 Pero (Milano - Italy)
 Tel. +39 02 3535955 r.a. Fax. +39 02 3539929
 E.Mail: info@omar-alluminio.it

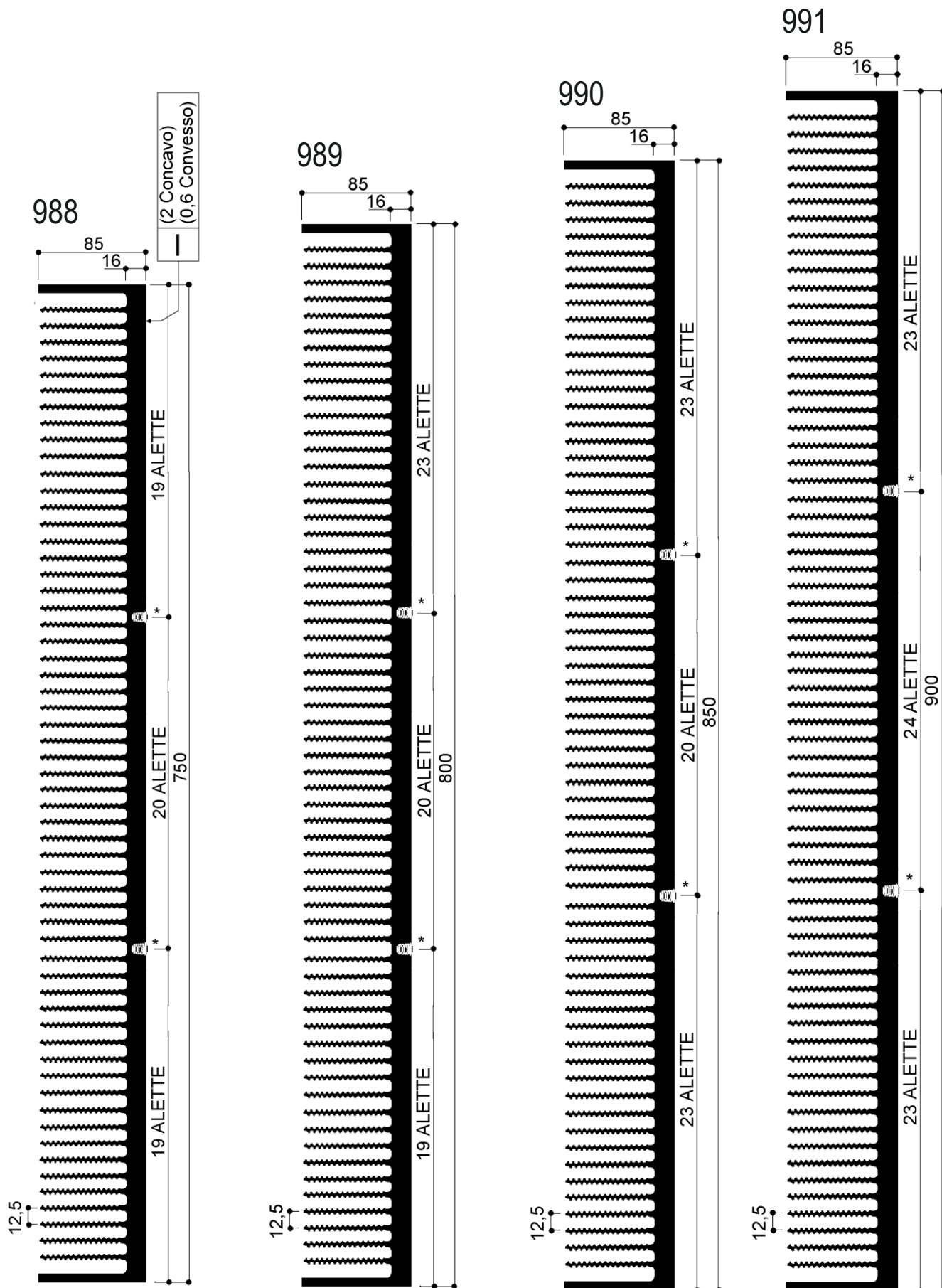

DISSIPATORI AD ALTO RENDIMENTO

DISEGNI META' DEL VERO (1:2)- SCALE 1:2

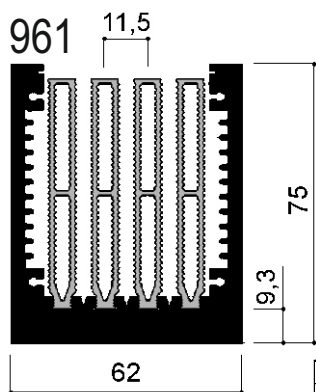

Resistenza termica (KW) in ventilazione forzata

Lg. (mm)	100	200	300
R _{th} a 5m/s	0,23	0,18	0,14

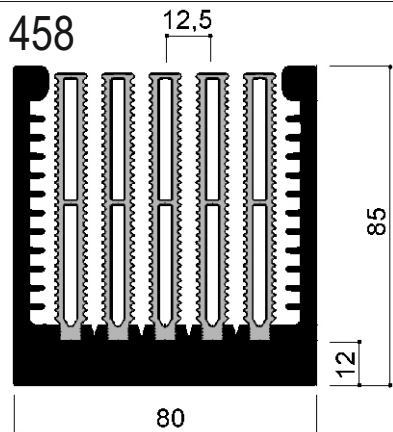
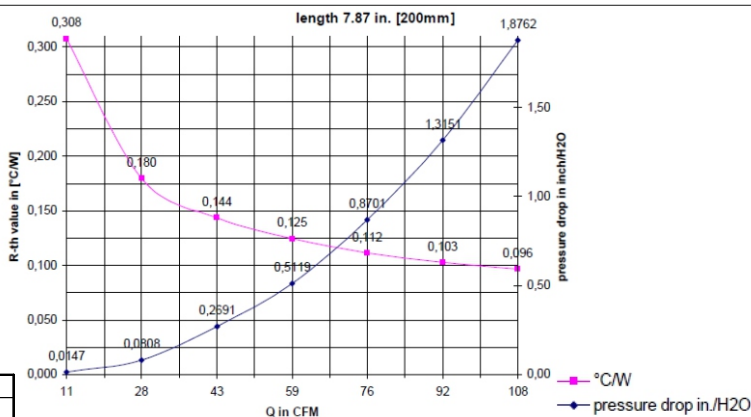

Resistenza termica (KW) in ventilazione forzata

Lg. (mm)	100	200	300
R _{th} a 5m/s	0,165	0,13	0,1

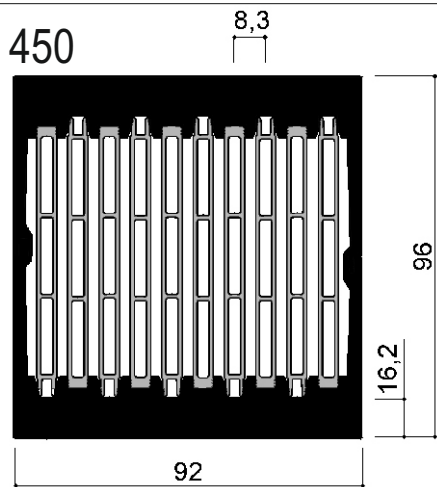
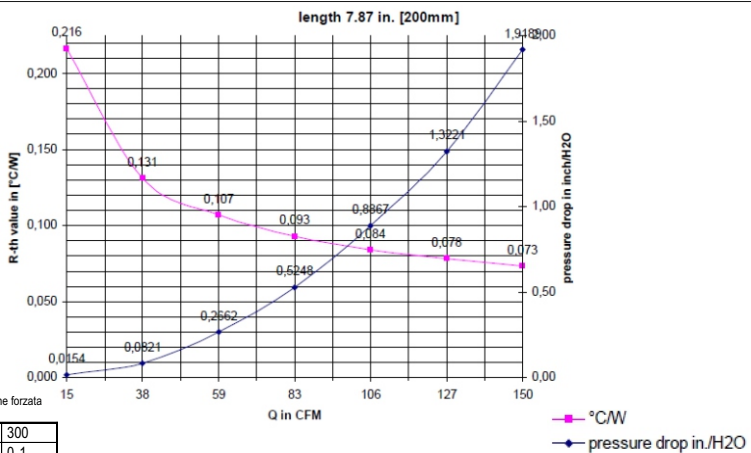

Resistenza termica (KW) in ventilazione forzata

Lg. (mm)	100	200	300
R _{th} a 5m/s	0,13	0,1	0,08

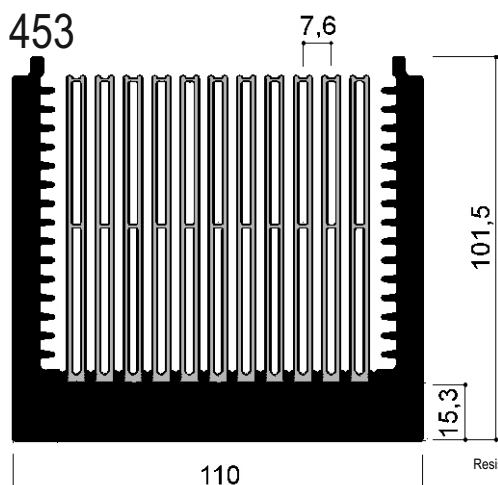
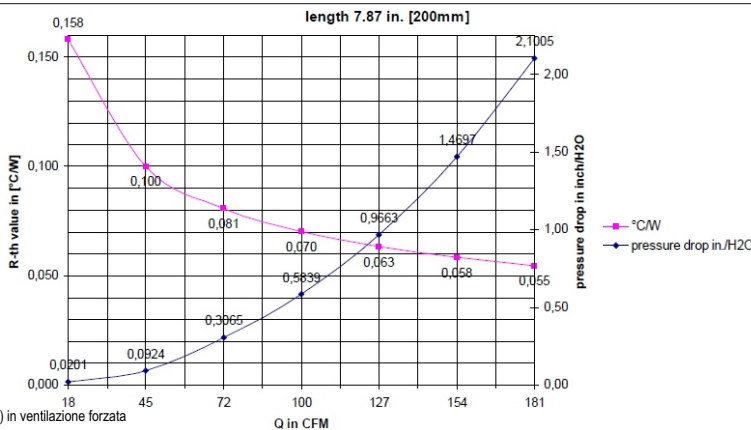

Resistenza termica (KW) in ventilazione forzata

Lg. (mm)	100	200	300
R _{th} a 11 m/s	0,0915	0,0579	0,0450

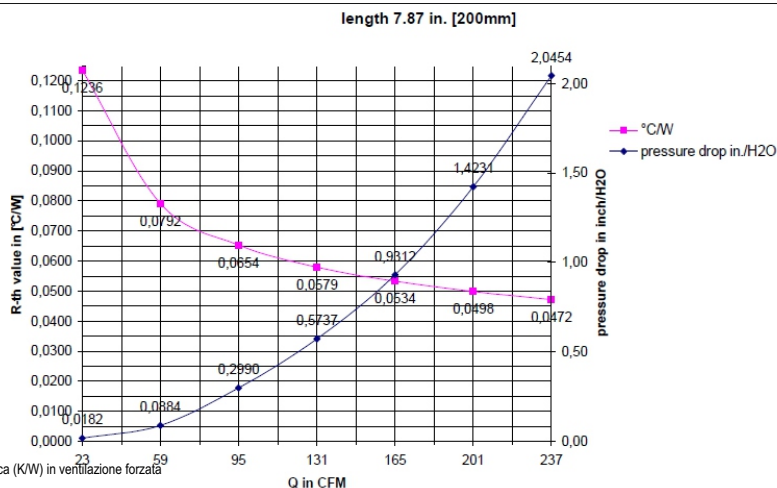

Via Newton, n.12

20016 Pero (Milano - Italy)

Tel. +39 02 3535955 r.a. Fax. +39 02 3539929

E-Mail: info@omar-alluminio.it

Cataloghi Online: www.omar-alluminio.it

www.omar-alluminio.com

PROFILATI ALLUMINIO A DISEGNO / STANDARD / SPECIALI / E PER:

ELETTRONICA / LED / FOTOVOLTAICO / AUTOMAZIONE ROBOTICA / PNEUMATICA / AUTOMOTIVE



DISSIPATORI AD ALTO RENDIMENTO

DISEGNI META' DEL VERO (1:2)- SCALE 1:2



Via Newton, n.12
20016 Pero (Milano - Italy)
Tel. +39 02 3535955 r.a. Fax. +39 02 3539929
E. Mail: info@omar-alluminio.it

Cataloghi Online: www.omar-alluminio.it
www.omar-alluminio.com
PROFILATI ALLUMINIO A DISEGNO / STANDARD / SPECIALI / E PER:
ELETTRONICA / LED / FOTOVOLTAICO / AUTOMAZIONE ROBOTICA / PNEUMATICA / AUTOMOTIVE

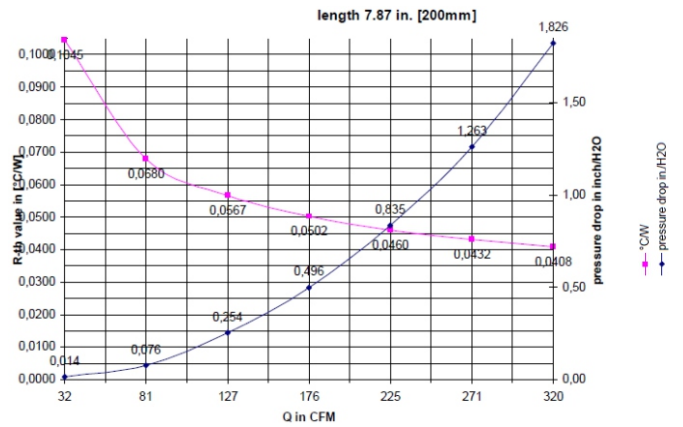
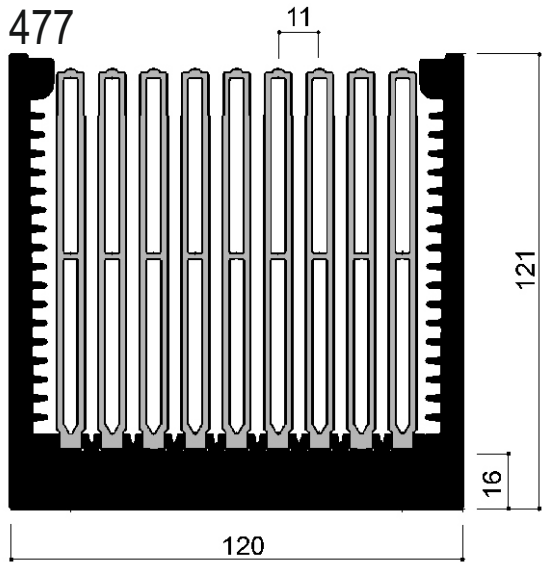

Resistenza termica (KW) in ventilazione forzata

Lg. (mm)	100	200	300
R _n a 5m/s	0,11	0,068	0,052

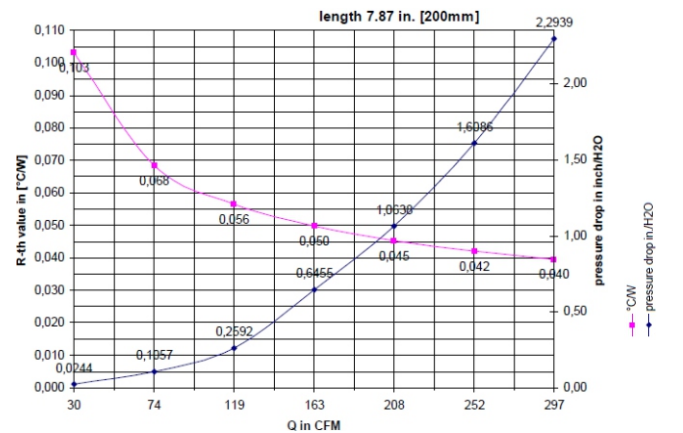
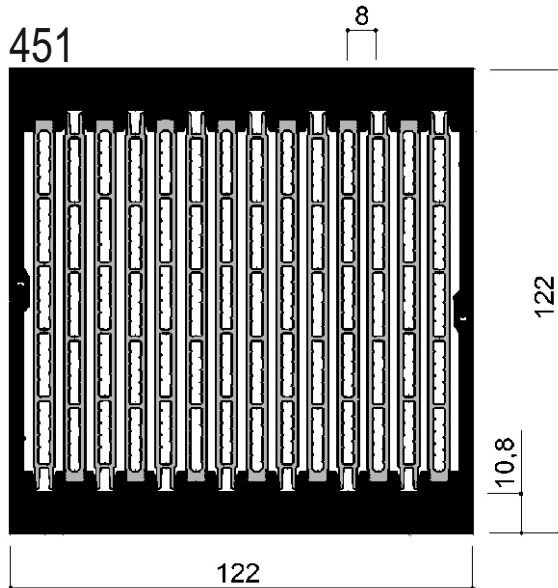

Resistenza termica (KW) in ventilazione forzata

Lg. (mm)	100	200	300
R _n a 5m/s	0,082	0,068	0,052

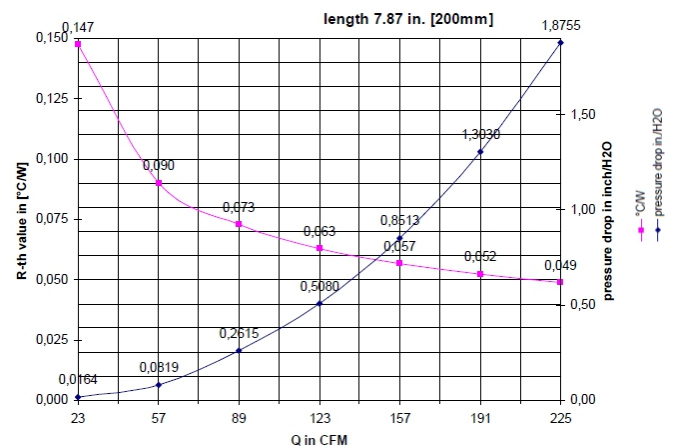
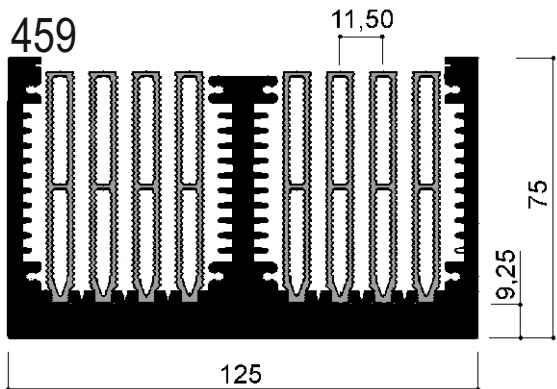

DISSIPATORI AD ALTO RENDIMENTO



DISEGNI META' DEL VERO (1:2)- SCALE 1:2

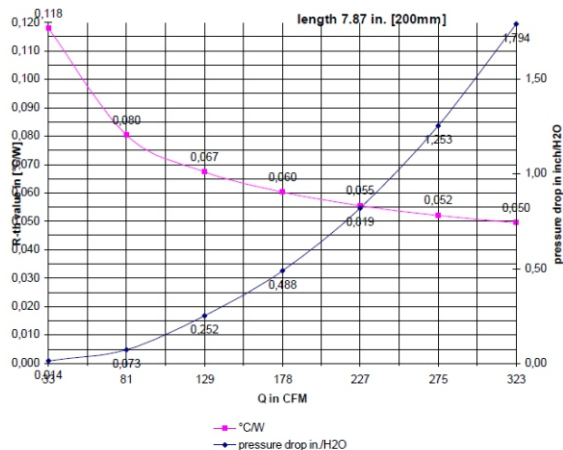
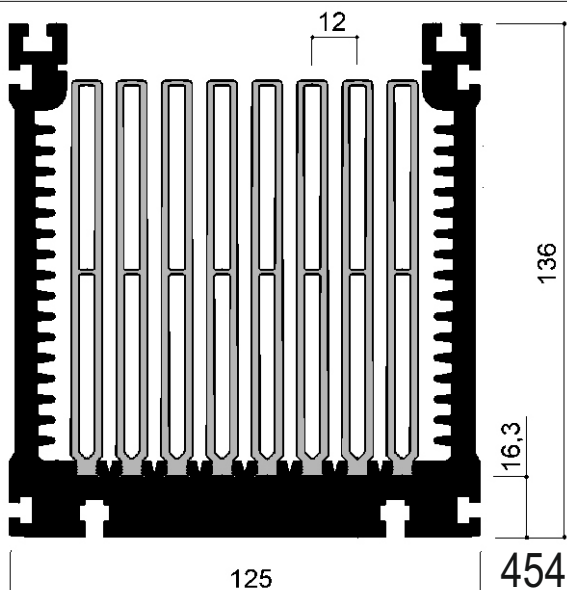

Resistenza termica (KW) in ventilazione forzata

Lg. (mm)	100	200	300
R _{th} a 5m/s	0,13	0,08	0,06

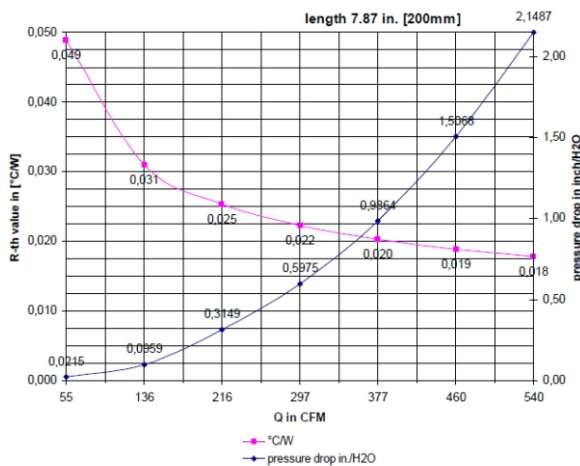
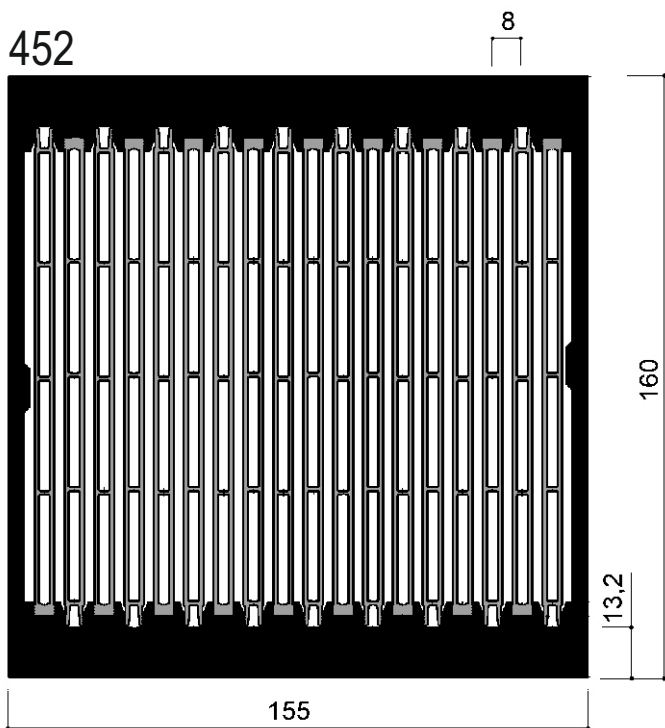

Resistenza termica (KW) in ventilazione forzata

Lg. (mm)	100	200	300
R _{th} a 5m/s	0,046	0,031	0,025

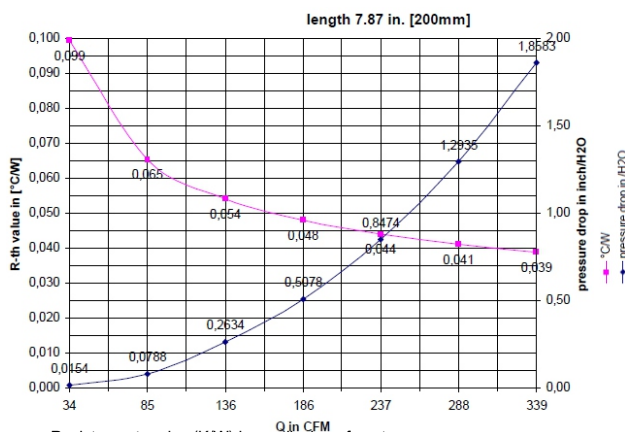
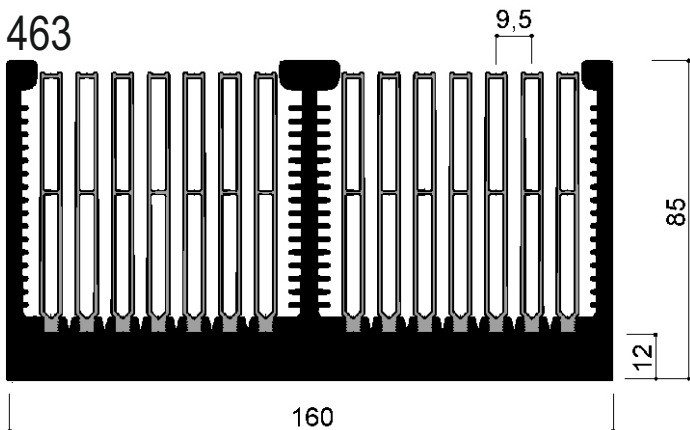

Resistenza termica (KW) in ventilazione forzata

Lg. (mm)	100	200	300
R _{th} a 5m/s	0,082	0,065	0,05

Via Newton, n. 12

20016 Pero (Milano - Italy)

Tel. +39 02 3535955 r.a. Fax. +39 02 3539929

E-Mail: info@omar-alluminio.it

Cataloghi Online: www.omar-alluminio.it

www.omar-alluminio.com

PROFILATI ALLUMINIO A DISEGNO / STANDARD / SPECIALI / E PER:

ELETTRONICA / LED / FOTOVOLTAICO / AUTOMAZIONE ROBOTICA / PNEUMATICA / AUTOMOTIVE



DISSIPATORI AD ALTO RENDIMENTO



DISEGNI META' DEL VERO (1:2)- SCALE 1:2

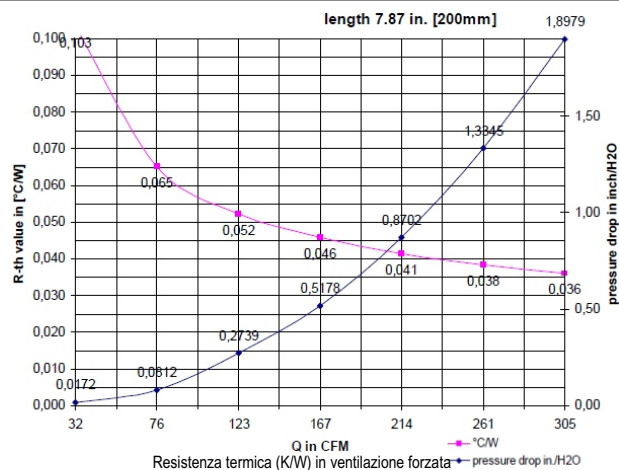
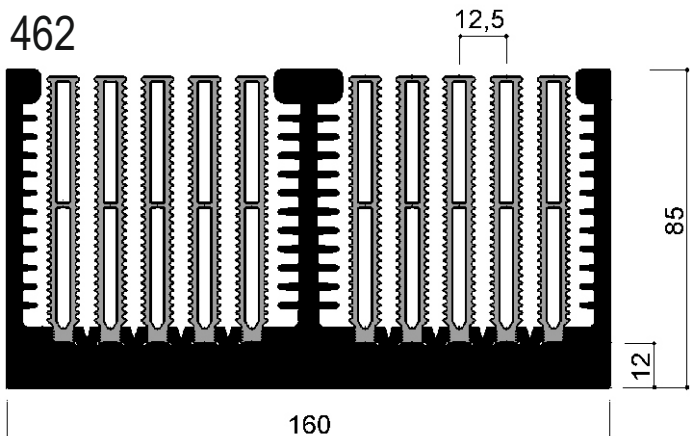

Lg. (mm)	100	200	300
R _{th} a 5m/s	0,082	0,065	0,05

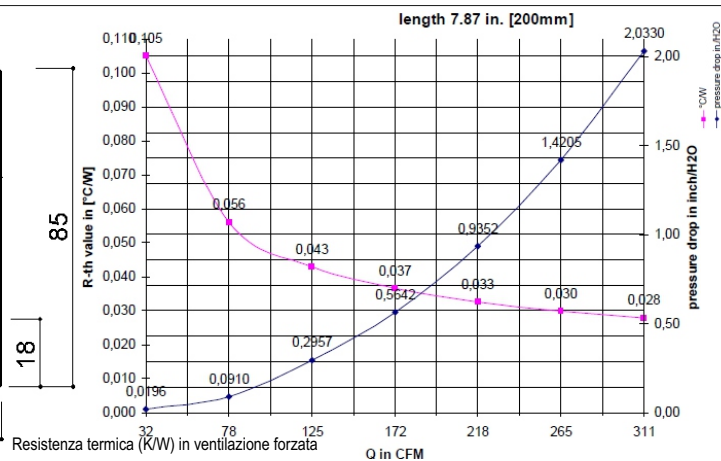
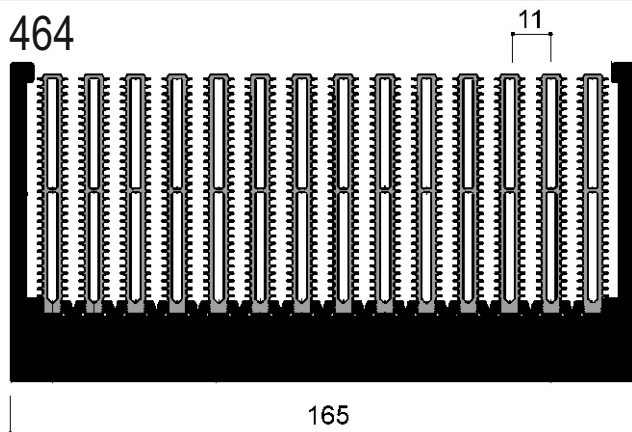

Lg. (mm)	100	200	300
R _{th} a 5m/s	0,077	0,056	0,048



FOTO DI ESEMPIO: TAGLIO A MISURA DISSIPATORI AD ALTO RENDIMENTO DI GROSSE DIMENSIONI

Via Newton, n.12
20016 Pero (Milano - Italy)
Tel. +39 02 3535955 r.a. Fax. +39 02 3539929
E. Mail: info@omar-alluminio.it

Cataloghi Online: www.omar-alluminio.it
www.omar-alluminio.com
PROFILATI ALLUMINIO A DISEGNO / STANDARD / SPECIALI / E PER:
ELETTRONICA / LED / FOTOVOLTAICO / AUTOMAZIONE ROBOTICA / PNEUMATICA / AUTOMOTIVE

OMAR s.r.l.
PROFILATI ALLUMINIO
ALTA TECNOLOGIA

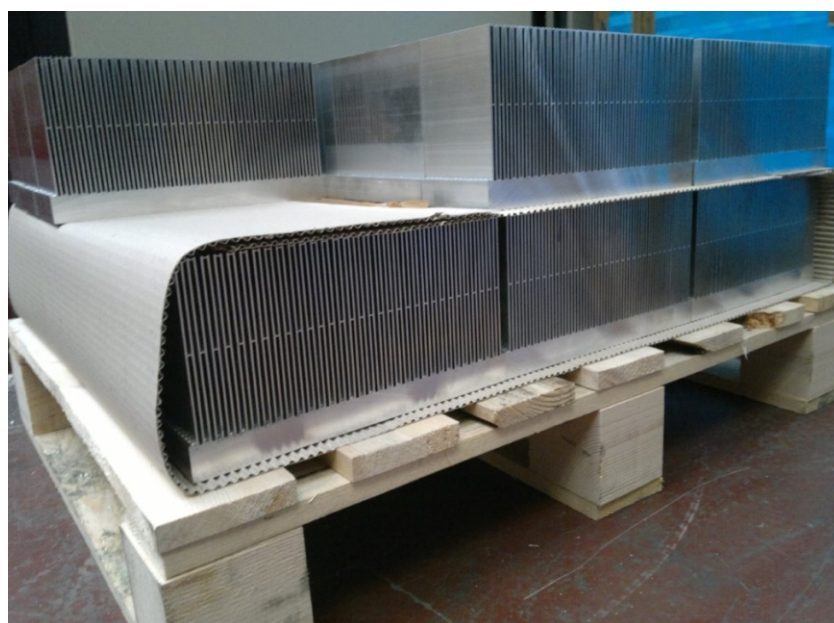
DISSIPATORI AD ALTO RENDIMENTO

DISEGNI META' DEL VERO (1:2)- SCALE 1:2

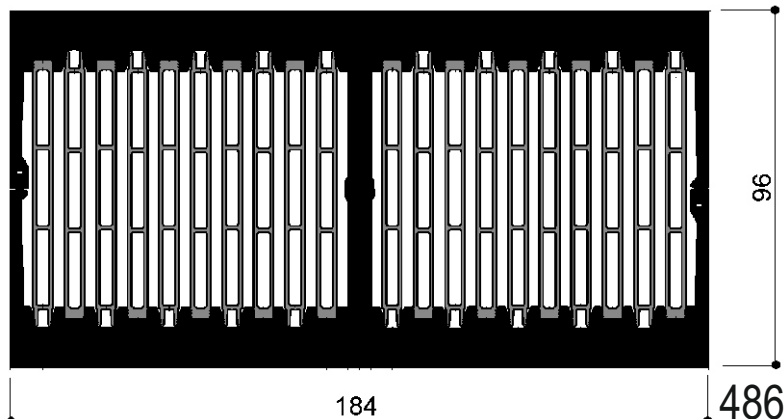

length 11.81 in. [300mm]

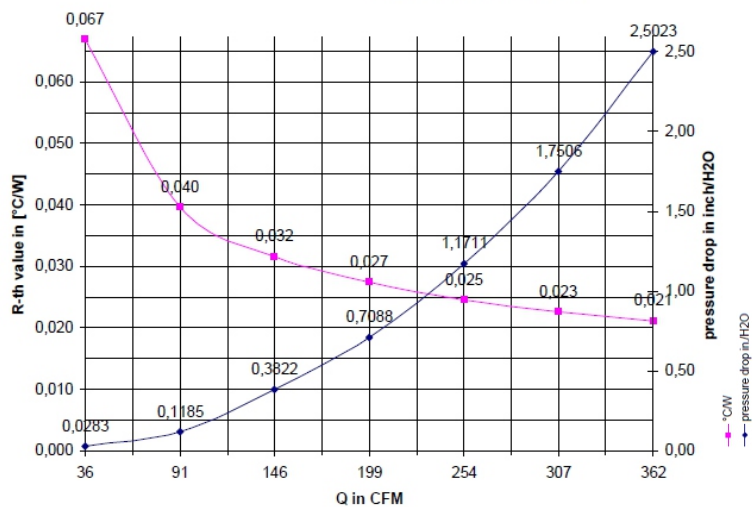

Resistenza termica (K/W) in ventilazione forzata

Lg. (mm)	100	200	300
R _{th} 5m/s	0,065	0,05	0,04



FOTO DI ESEMPIO: SI ESEGUONO OPERAZIONI DI TRINCIATURA SU PROFILI ESTRUSI IN ALLUMINIO



length 7.87 in. [200mm]

Resistenza termica (K/W) in ventilazione forzata

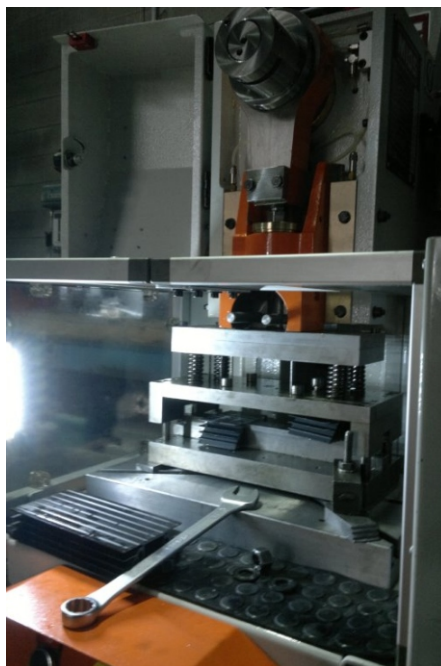
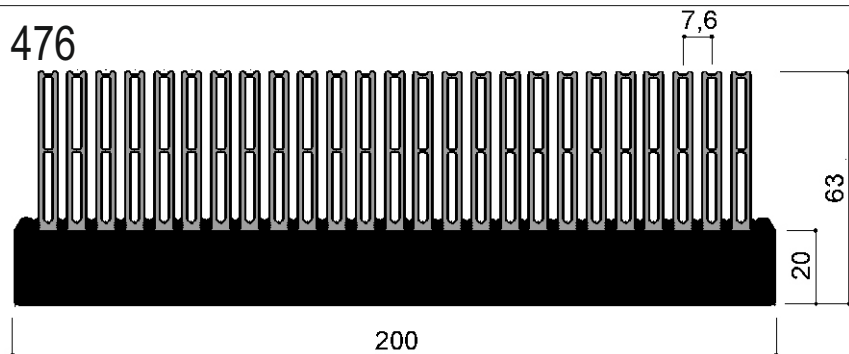
Lg. (mm)	100	200	300
R _{th} a 11 m/s	0,0617	0,042	0,034

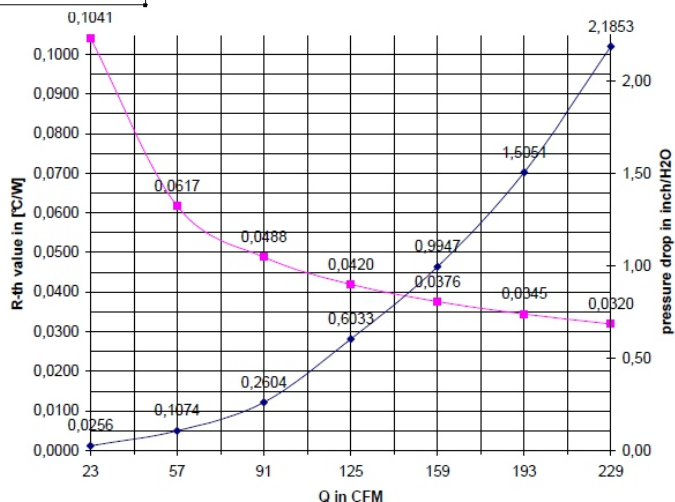
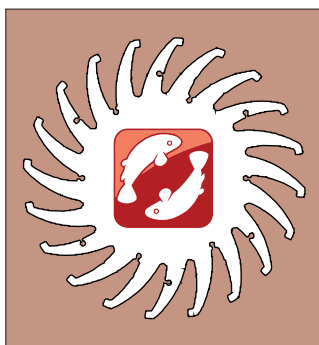

Via Newton, n.12
20016 Pero (Milano - Italy)
Tel. +39 02 3535955 r.a. Fax. +39 02 3539929
E-Mail: info@omar-alluminio.it

Cataloghi Online: www.omar-alluminio.it
www.omar-alluminio.com

PROFILATI ALLUMINIO A DISEGNO / STANDARD / SPECIALI / E PER:
ELETTRONICA / LED / FOTOVOLTAICO / AUTOMAZIONE ROBOTICA / PNEUMATICA / AUTOMOTIVE



DISSIPATORI AD ALTO RENDIMENTO



DISEGNI META' DEL VERO (1:2)- SCALE 1:2

475

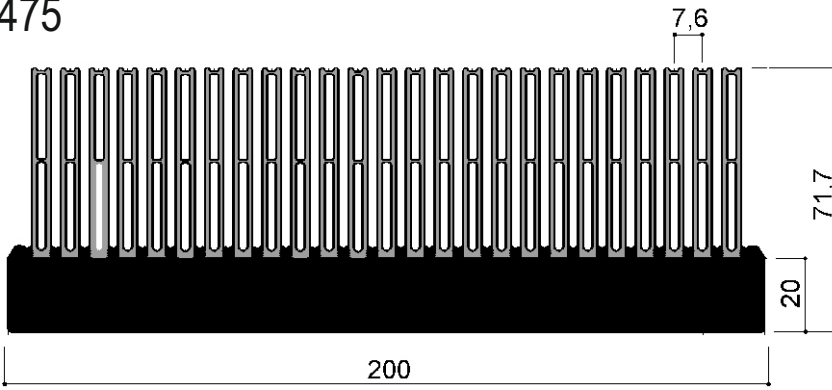

length 7.87 in. [200mm]

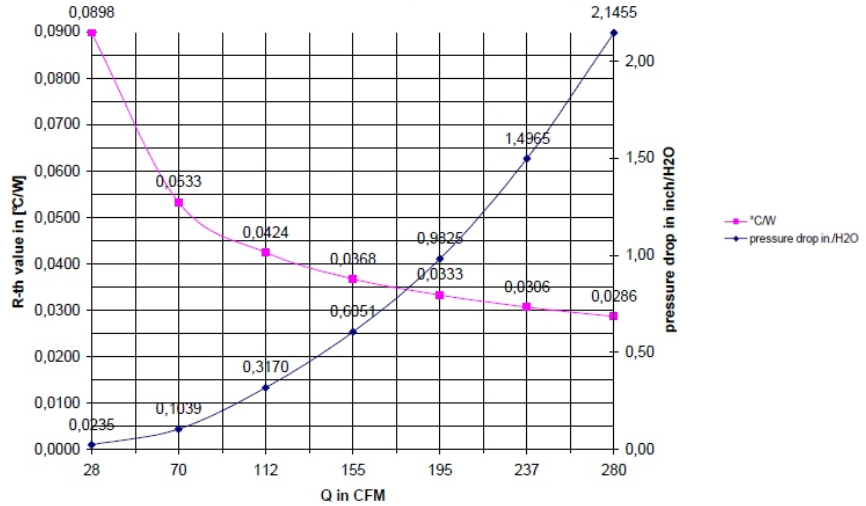

455

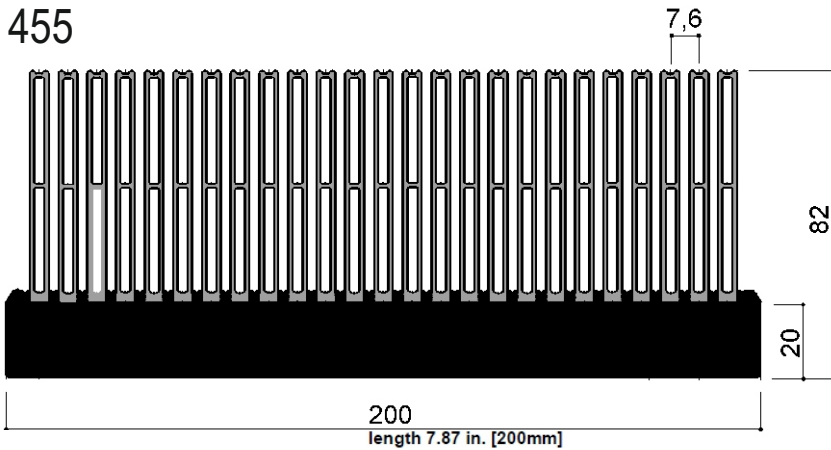

length 7.87 in. [200mm]



FOTO DI ESEMPIO: SI ESEGUONO LAVORAZIONI MECCANICHE SU PROFILI ESTRUSI IN ALLUMINIO

Cataloghi Online: www.omar-alluminio.it
www.omar-alluminio.com

PROFILATI ALLUMINIO A DISEGNO / STANDARD / SPECIALI / E PER:
 ELETTRONICA / LED / FOTOVOLTAICO / AUTOMAZIONE ROBOTICA / PNEUMATICA / AUTOMOTIVE

Via Newton, n.12
 20016 Pero (Milano - Italy)
 Tel. +39 02 3535955 r.a. Fax. +39 02 3539929
 E.Mail: info@omar-alluminio.it

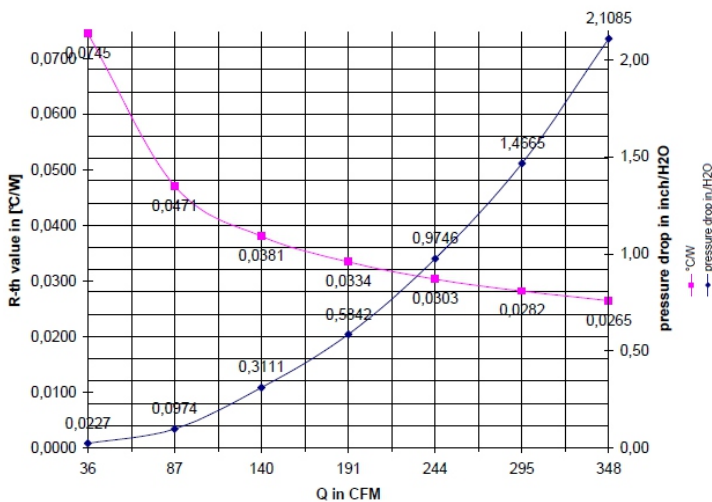

DISSIPATORI AD ALTO RENDIMENTO



DISEGNI META' DEL VERO (1:2)- SCALE 1:2

465

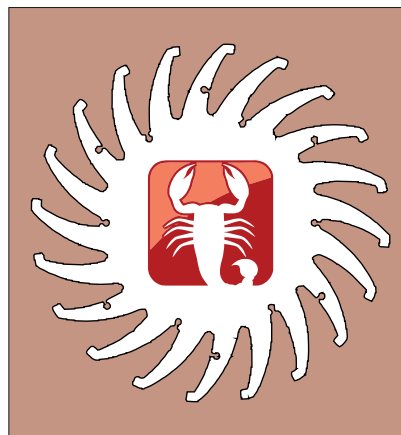
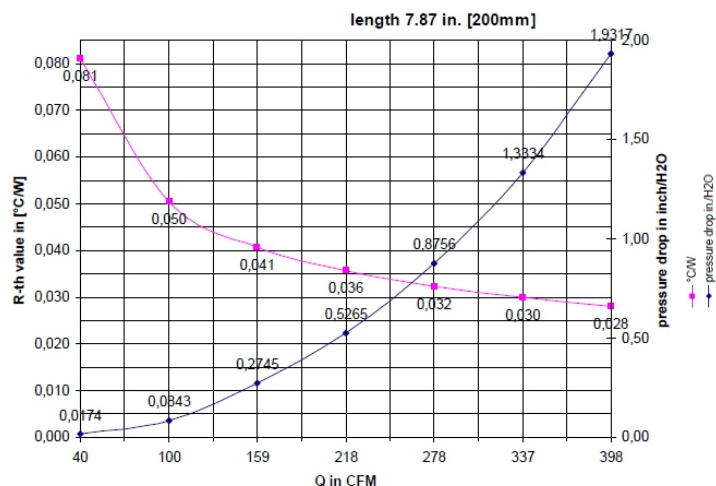
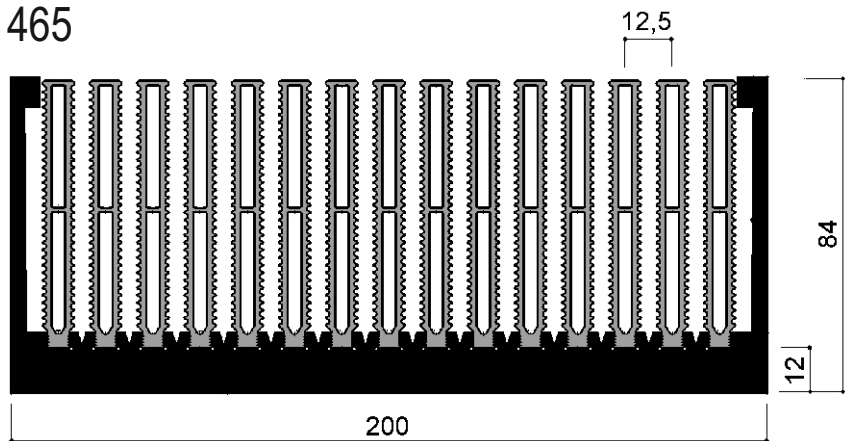

460

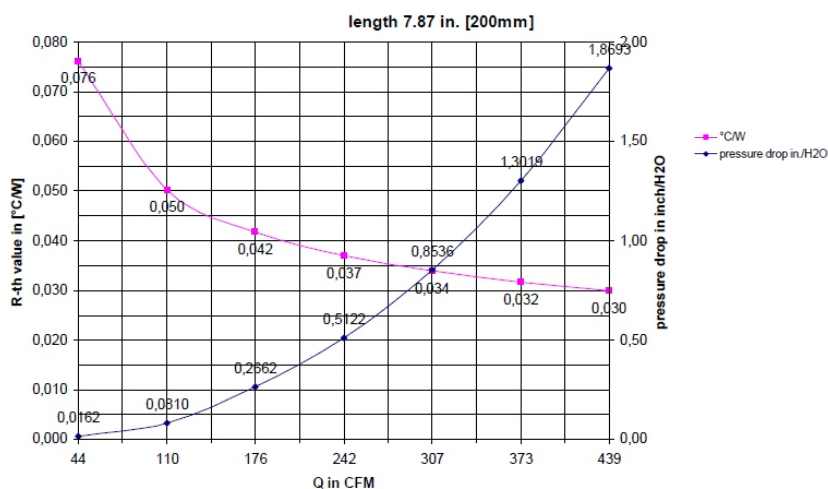
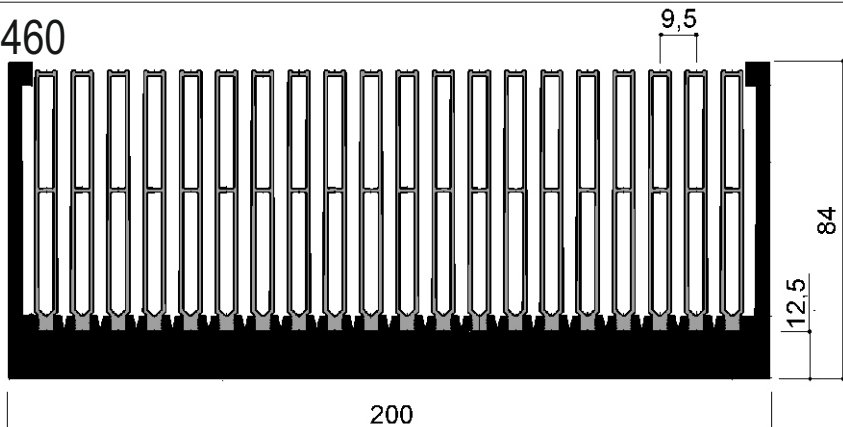

Cataloghi Online: www.omar-alluminio.it
www.omar-alluminio.com

Via Newton, n.12
 20016 Pero (Milano - Italy)
 Tel. +39 02 3535955 r.a. Fax. +39 02 3539929
 E-Mail: info@omar-alluminio.it

PROFILATI ALLUMINIO A DISEGNO / STANDARD / SPECIALI / E PER:
 ELETTRONICA / LED / FOTOVOLTAICO / AUTOMAZIONE ROBOTICA / PNEUMATICA / AUTOMOTIVE



DISSIPATORI AD ALTO RENDIMENTO

DISEGNI META' DEL VERO (1:2)- SCALE 1:2



Via Newton, n.12
20016 Pero (Milano - Italy)
Tel. +39 02 3535955 r.a. Fax. +39 02 3539929
E. Mail: info@omar-alluminio.it

Cataloghi Online: www.omar-alluminio.it
www.omar-alluminio.com

PROFILATI ALLUMINIO A DISEGNO / STANDARD / SPECIALI / E PER:
ELETTRONICA / LED / FOTOVOLTAICO / AUTOMAZIONE ROBOTICA / PNEUMATICA / AUTOMOTIVE

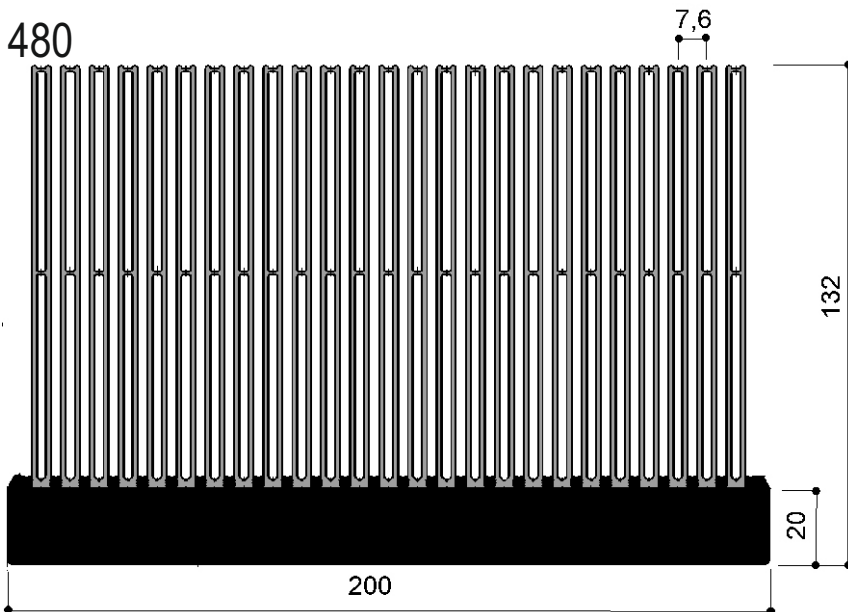

Resistenza termica (K/W) in ventilazione forzata

Lg. (mm)	200	300	400
Rth 5m/s	0,0414	0,0254	0,0193

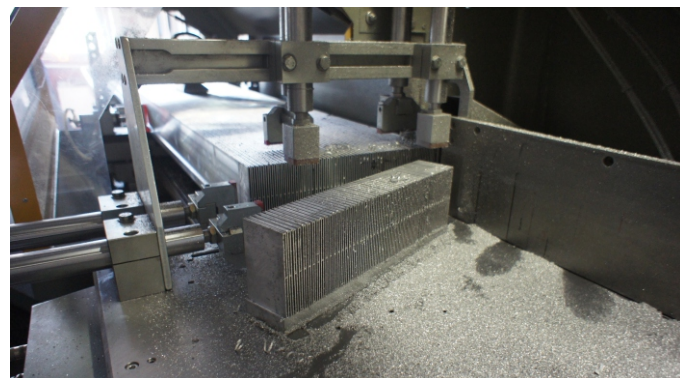
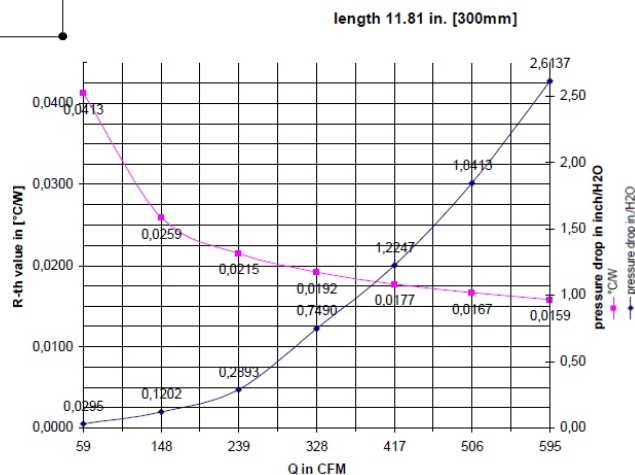

N.3 LINEE DI TAGLIO: SI ESEGUONO TAGLI SU PROFILI IN ALLUMINIO ANCHE DI GRANDI DIMENSIONI

DISSIPATORI AD ALTO RENDIMENTO

DISEGNI META' DEL VERO (1:2) - SCALE 1:2

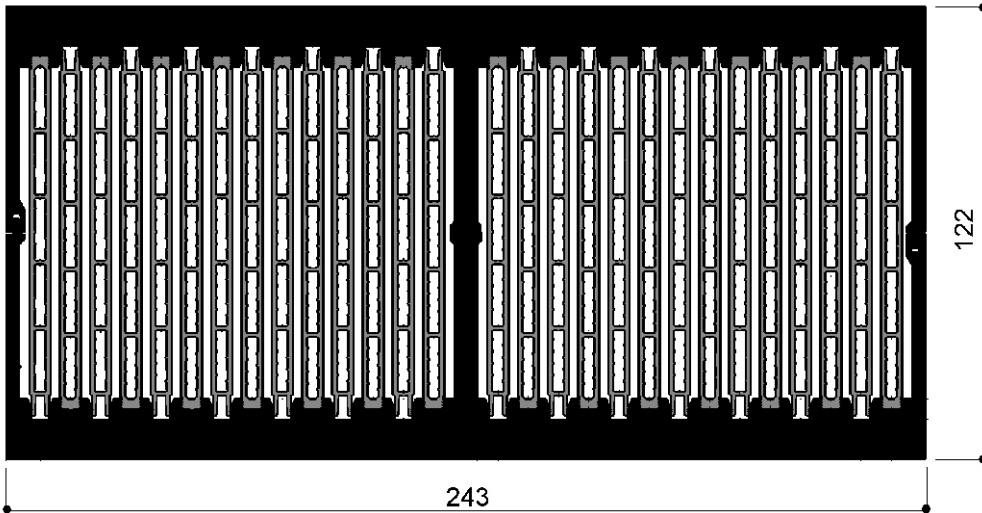

487

Resistenza termica (K/W) in ventilazione forzata

Lg. (mm)	100	200	300
Rth 5m/s	0,041	0,034	0,026

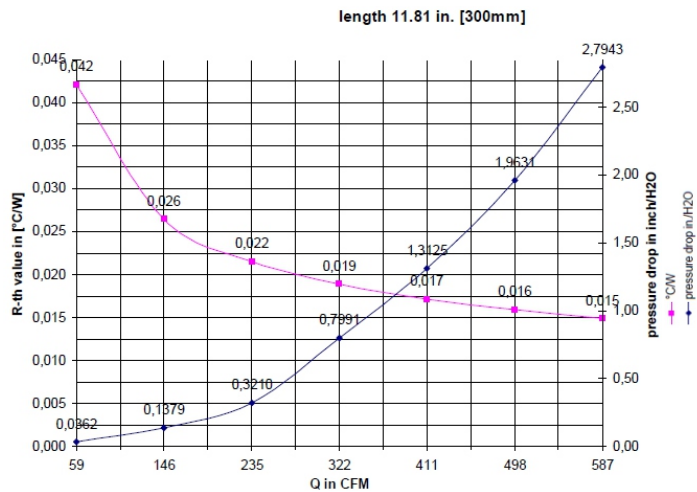

484

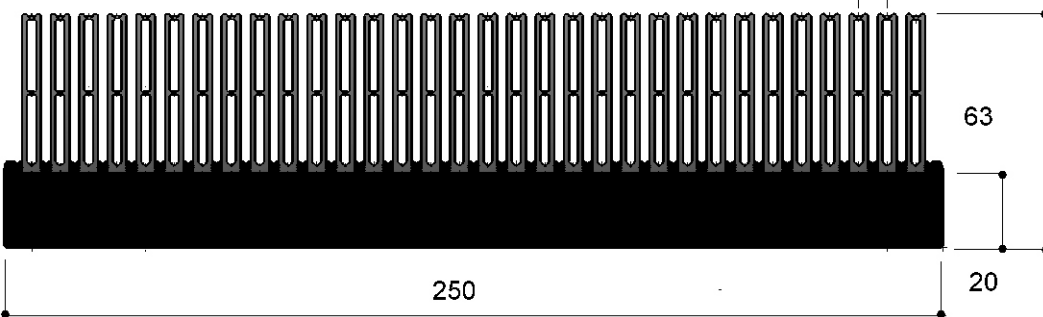

Resistenza termica (K/W) in ventilazione forzata

Lg. (mm)	100	200	300
Rth 11m/s	0,0480	0,0328	0,0265

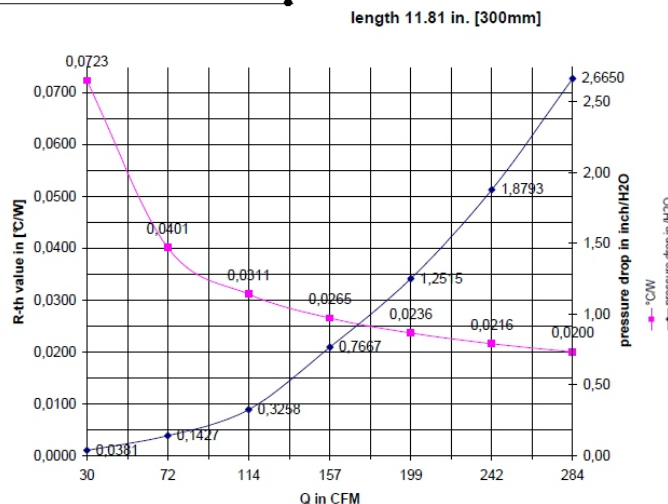

Cataloghi Online: www.omar-alluminio.it
www.omar-alluminio.com

PROFILATI ALLUMINIO A DISEGNO / STANDARD / SPECIALI / E PER:
 ELETTRONICA / LED / FOTOVOLTAICO / AUTOMAZIONE ROBOTICA / PNEUMATICA / AUTOMOTIVE



Via Newton, n.12
 20016 Pero (Milano - Italy)
 Tel. +39 02 3535955 r.a. Fax. +39 02 3539929
 E-Mail: info@omar-alluminio.it

DISSIPATORI AD ALTO RENDIMENTO

DISEGNI META' DEL VERO (1:2)- SCALE 1:2



Via Newton, n.12
20016 Pero (Milano - Italy)
Tel. +39 02 3535955 r.a. Fax. +39 02 3539929
E.Mai: info@omar-alluminio.it

Cataloghi Online: www.omar-alluminio.it
www.omar-alluminio.com

PROFILATI ALLUMINIO A DISEGNO / STANDARD / SPECIALI / E PER:

ELETRONICA / LED / FOTOVOLTAICO / AUTOMAZIONE ROBOTICA / PNEUMATICA / AUTOMOTIVE

483

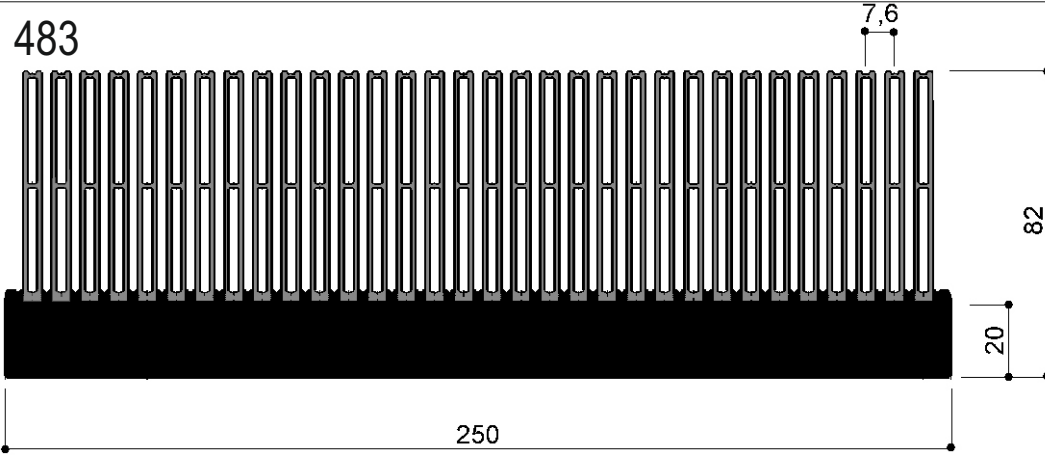

Resistenza termica (K/W) in ventilazione forzata

Lg. (mm)	100	200	300
R _{th,11m/s}	0,0400	0,0261	0,0207

length 11.81 in. [300mm]

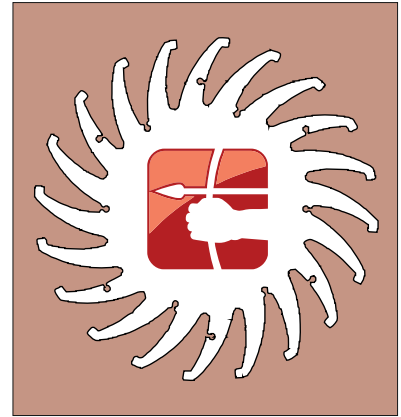
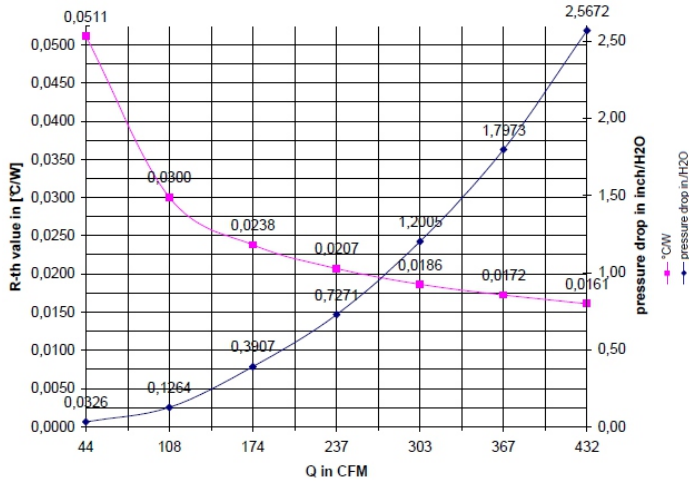

489

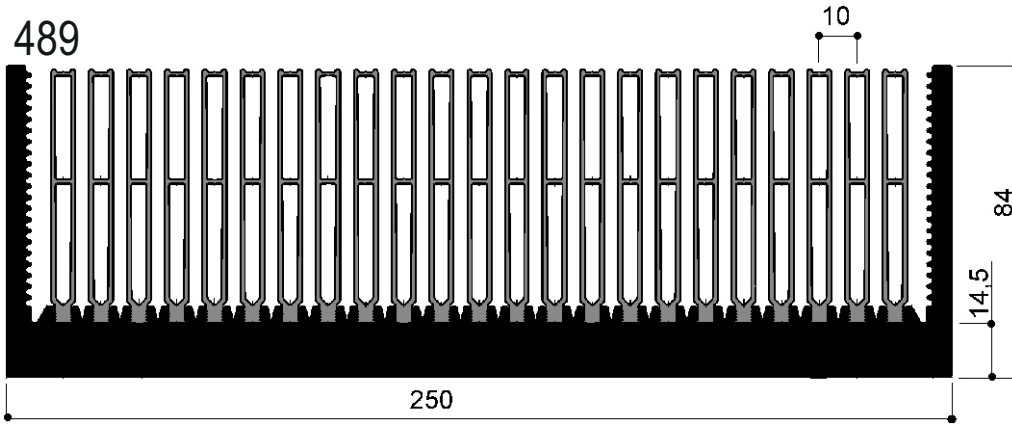

Resistenza termica (K/W) in ventilazione forzata

Lg. (mm)	100	200	300	400
R _{th,5/s}	0,0663	0,0438	0,0349	0,0300

length 15.74 in. [400mm]

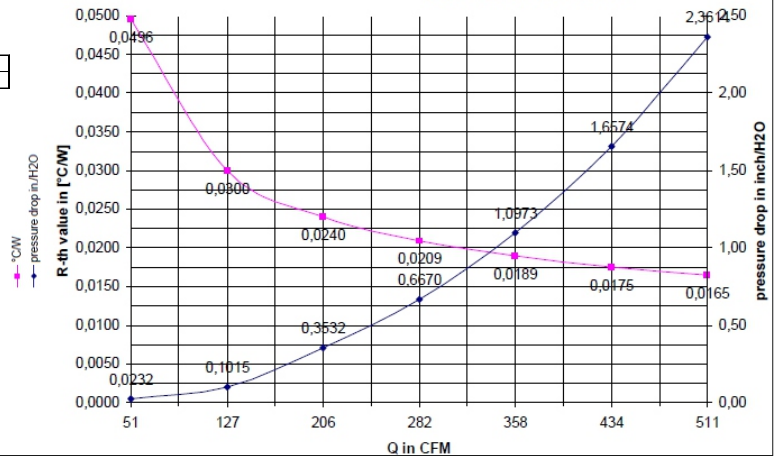

DISSIPATORI AD ALTO RENDIMENTO



DISEGNI META' DEL VERO (1:2)- SCALE 1:2

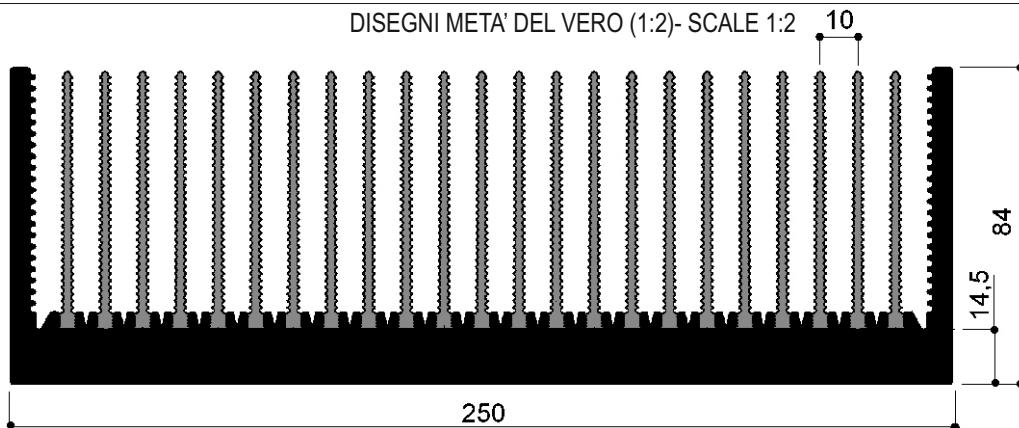

492

Resistenza termica (K/W) in ventilazione forzata

Lg. (mm)	100	200	300	400
Rth5/s	0,0963	0,0644	0,0516	0,0437

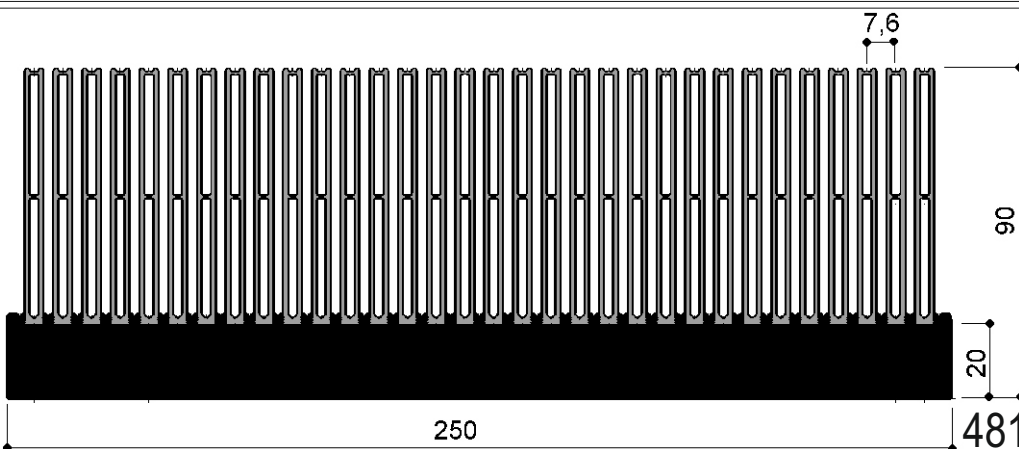
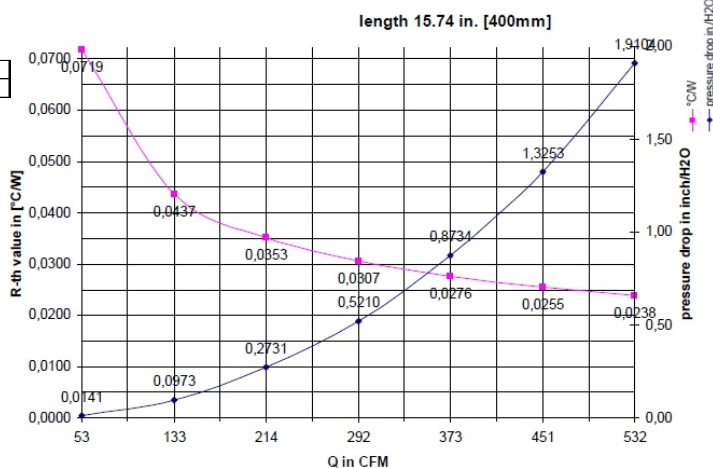

Resistenza termica (K/W) in ventilazione forzata

Lg. (mm)	100	200	300
Rth11m/s	0,0370	0,0239	0,0188

length 11.81 in. [300mm]



FOTO DI ESEMPIO: DISSIPATORI "FLOWER" A STOCK IN PRONTA CONSEGNA

Via Newton, n.12
20016 Pero (Milano - Italy)
Tel. +39 02 3535955 r.a. Fax. +39 02 3539929
E-Mail: info@omar-alluminio.it

Cataloghi Online: www.omar-alluminio.it

www.omar-alluminio.com

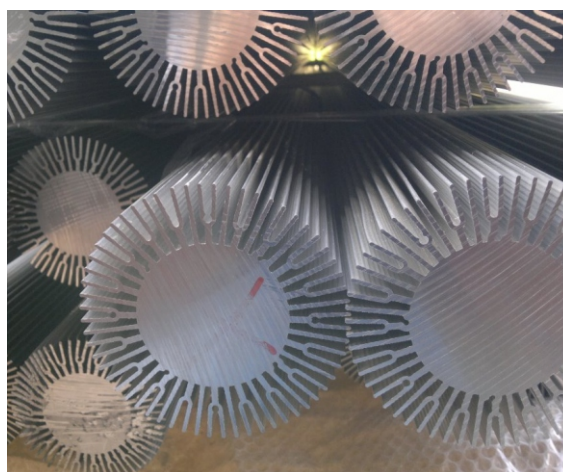
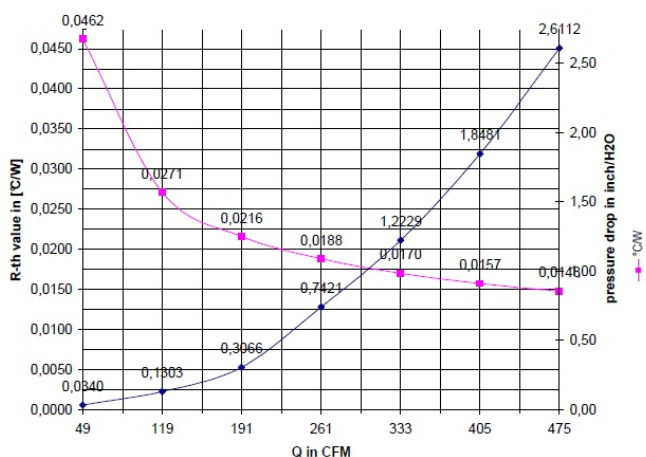
PROFILATI ALLUMINIO

A DISEGNO / STANDARD / SPECIALI E LORO DERIVATI



DISSIPATORI AD ALTO RENDIMENTO

DISEGNI META' DEL VERO (1:2)- SCALE 1:2

Via Newton, n. 12
20016 Pero (Milano - Italy)
Tel. +39 02 3535955 r.a. Fax. +39 02 3539929
E. Mail: info@omar-alluminio.it

Cataloghi Online: www.omar-alluminio.it
www.omar-alluminio.com

PROFILATI ALLUMINIO A DISEGNO / STANDARD / SPECIALI / E PER:
ELETTRONICA / LED / FOTOVOLTAICO / AUTOMAZIONE ROBOTICA / PNEUMATICA / AUTOMOTIVE

482

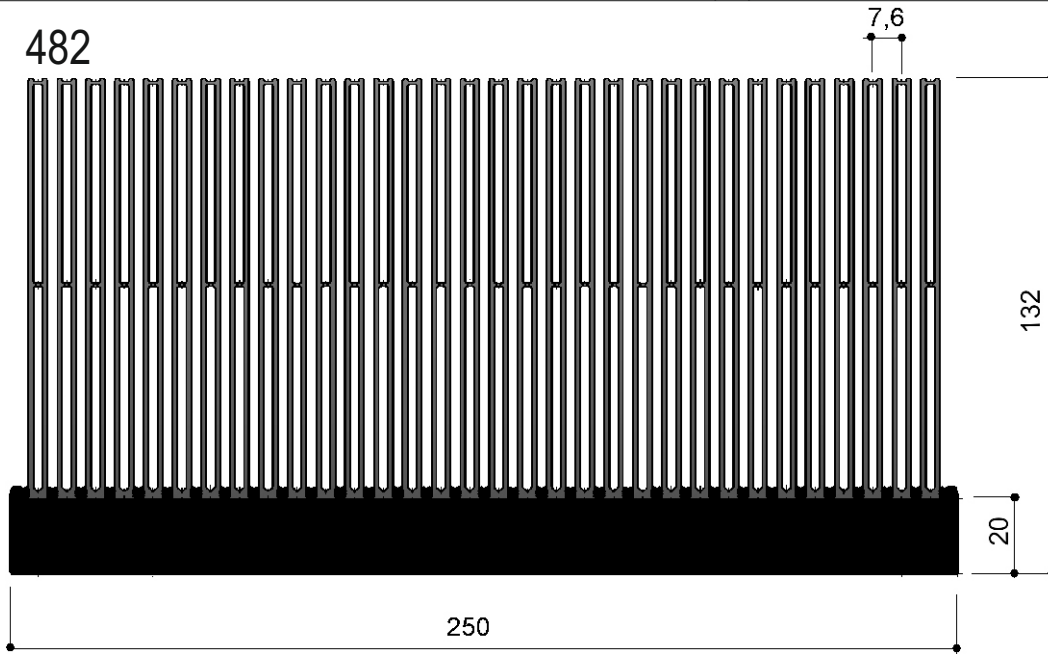

Resistenza termica (K/W) in ventilazione forzata

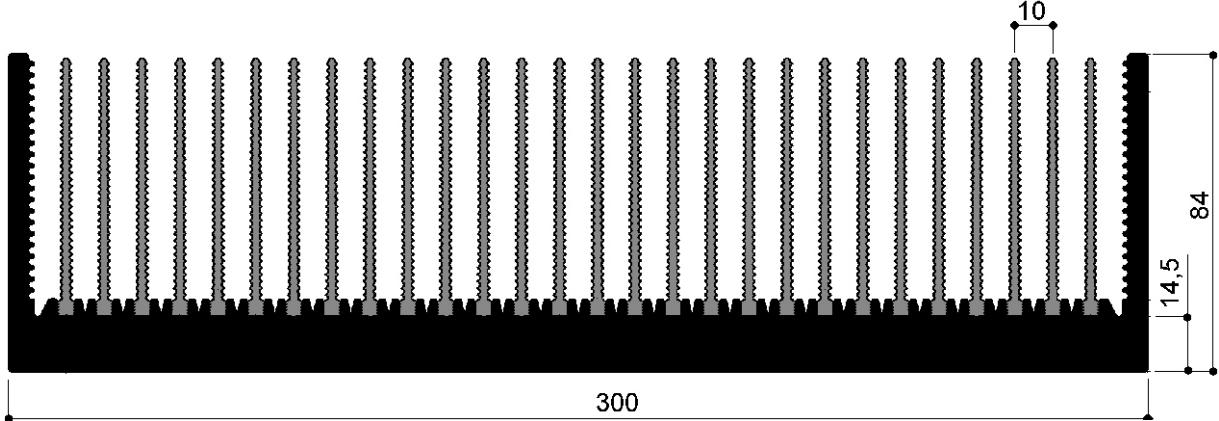
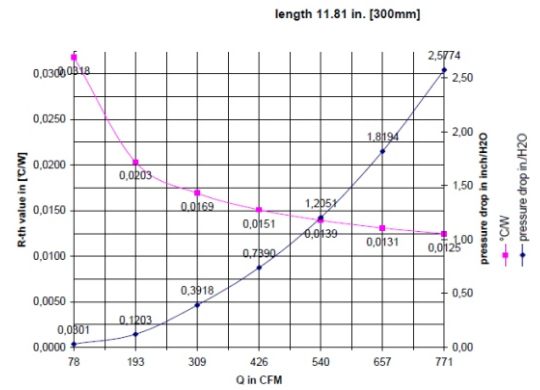

493

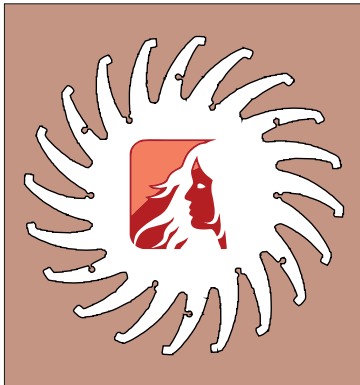
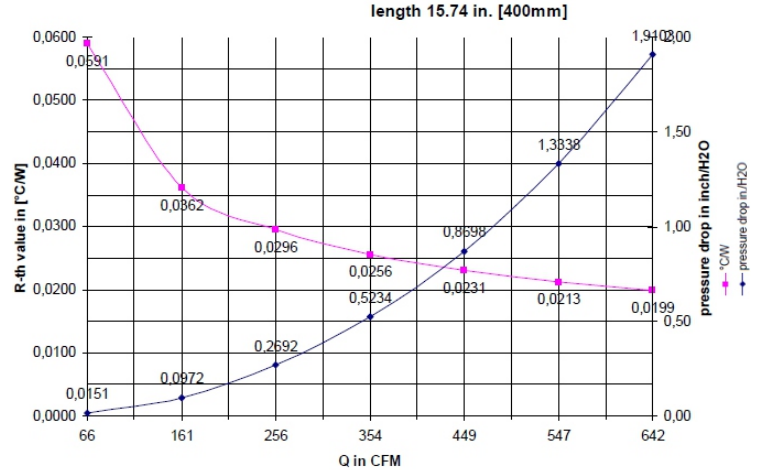

DISSIPATORI AD ALTO RENDIMENTO



DISEGNI FUORI SCALA

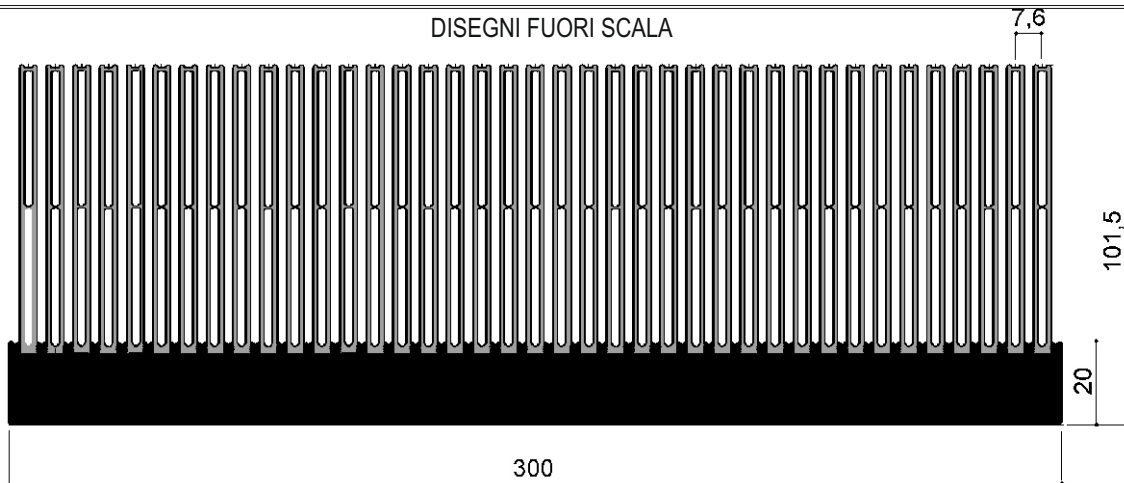

456

300

length 7.87 in. [200mm]

Resistenza termica (KW) in ventilazione forzata

Lg. (mm)	100	200	300	400
R _{th} a 11 m/s	0,00284	0,0181	0,0141	0,119

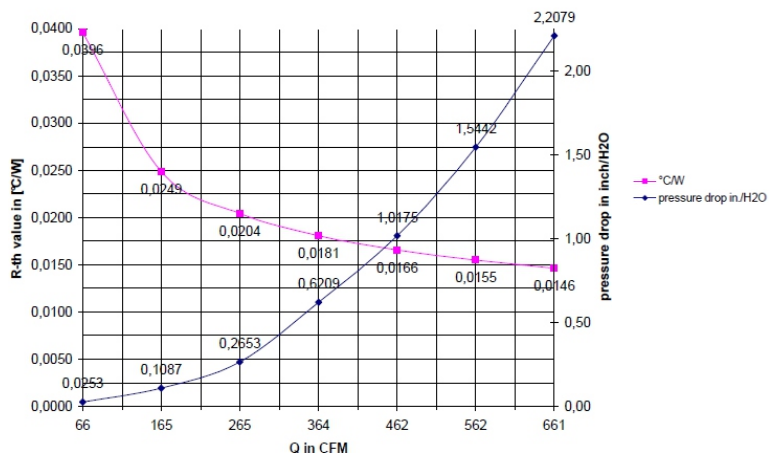

DISEGNI FUORI SCALA

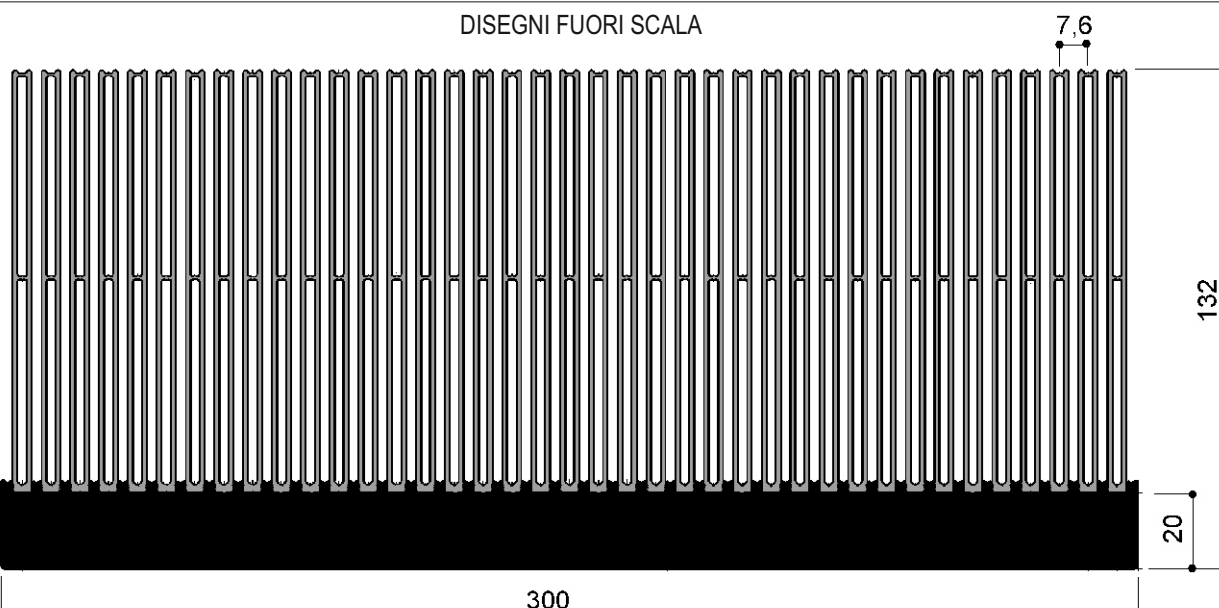

479

300

length 19.68 in. [500mm]

Resistenza termica (KW) in ventilazione forzata

Lg. (mm)	200	300	400
R _{th} 5 m/s	0,0163	0,0124	0,0103

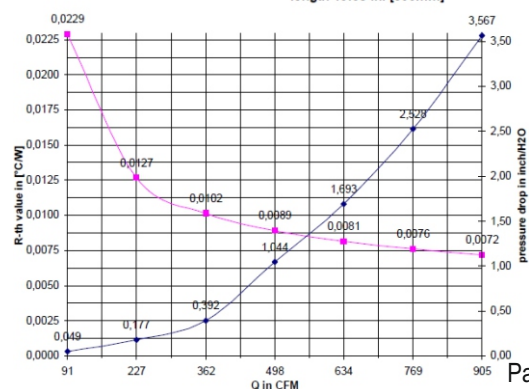

AGGIORNAMENTO CONTINUO - ED. DEL 02-2017 -RIPRODUZIONE VIETATA-
I valori espressi dalle curve sono puramente indicativi

Pag.43

Cataloghi Online: www.omar-alluminio.it
www.omar-alluminio.com
PROFILATI ALLUMINIO
 A DISEGNO / STANDARD / SPECIALI E LORO DERIVATI



Via Newton, n.12
 20016 Pero (Milano - Italy)
 Tel. +39 02 3535955 r.a. Fax. +39 02 3539929
 E-Mail: info@omar-alluminio.it

DISSIPATORI AD ALTO RENDIMENTO

DISEGNI FUORI SCALA



Via Newton, n.12
20016 Pero (Milano - Italy)
Tel. +39 02 3535955 r.a. Fax. +39 02 3539929
E.Mail: info@omar-alluminio.it

Cataloghi Online: www.omar-alluminio.it
www.omar-alluminio.com

PROFILATI ALLUMINIO A DISEGNO / STANDARD / SPECIALI / E PER:
ELETTRONICA / LED / FOTOVOLTAICO / AUTOMAZIONE ROBOTICA / PNEUMATICA / AUTOMOTIVE



FOTO DI ESEMPIO: PROFILI IN ALLUMINIO CARCASSE DI MOTORI ELETTRICI
TAGLIATI A MISURA STOCCATI SU PALLETT, IN PRONTA CONSEGNA

DISSIPATORI AD ALTO RENDIMENTO



DISEGNI FUORI SCALA

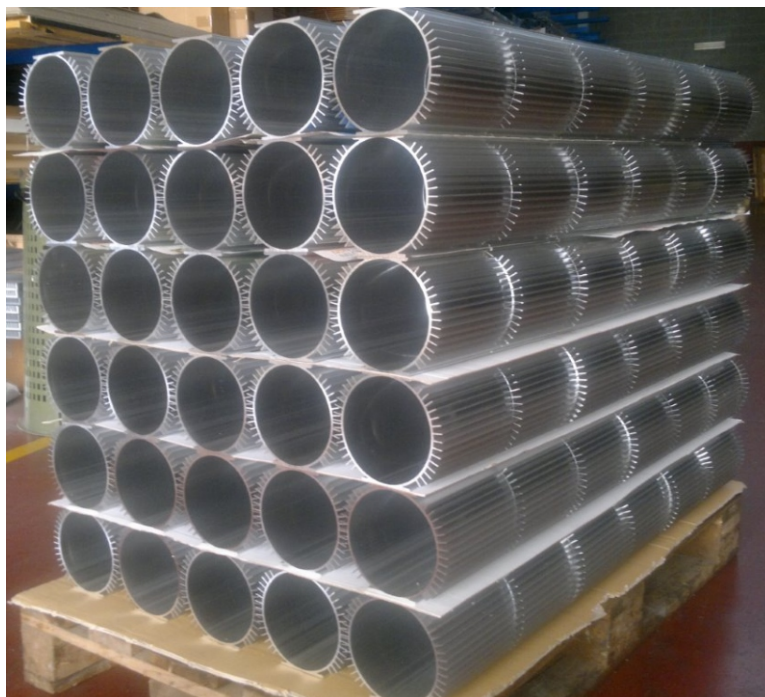
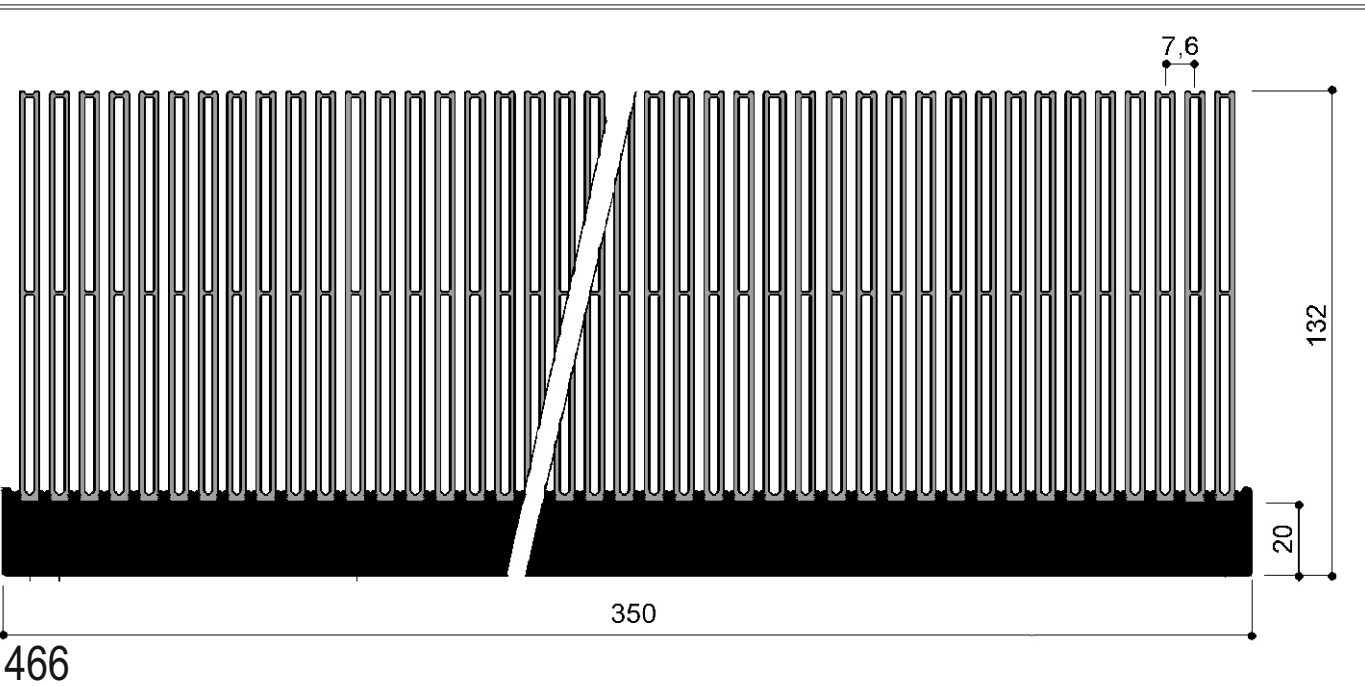
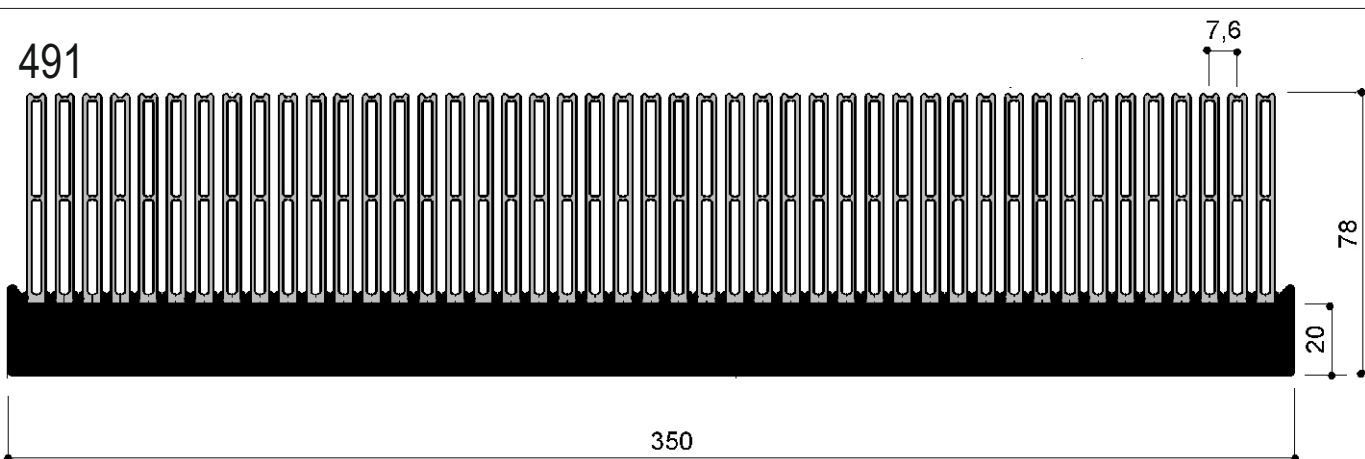
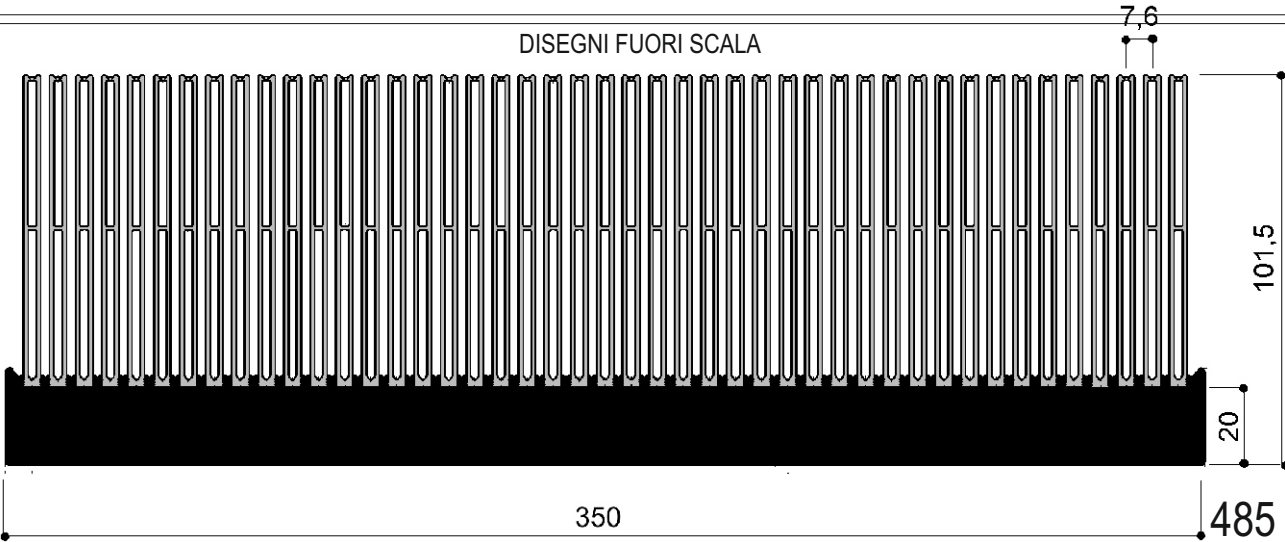

Resistenza termica (KW) in ventilazione forzata

Lg. (mm)	200	300	400
Rth 11 m/s	0,0157	0,0122	0,0103

length 15.75 in. [400mm]



FOTO DI ESEMPIO: DISSIPATORI A VENTILAZIONE FORZATA PER 6 SCHEDE LED

DISEGNI FUORI SCALA

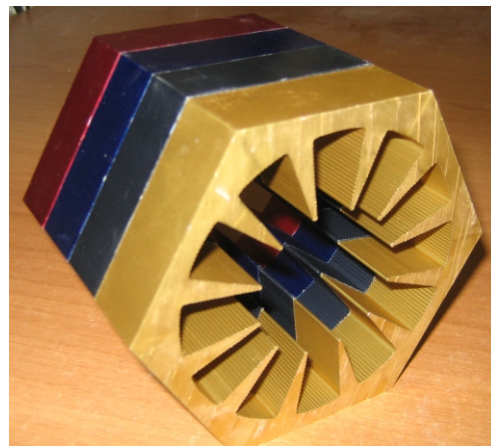
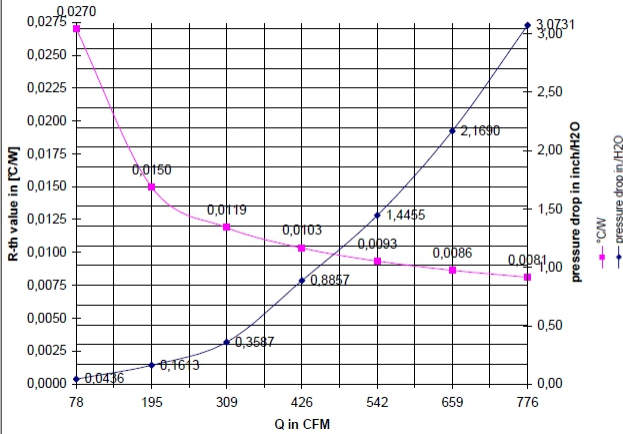
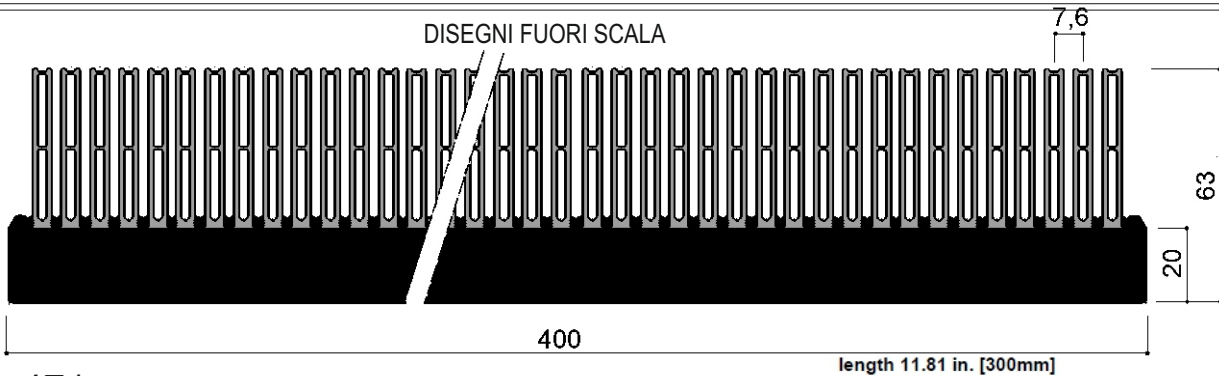

471

length 11.81 in. [300mm]

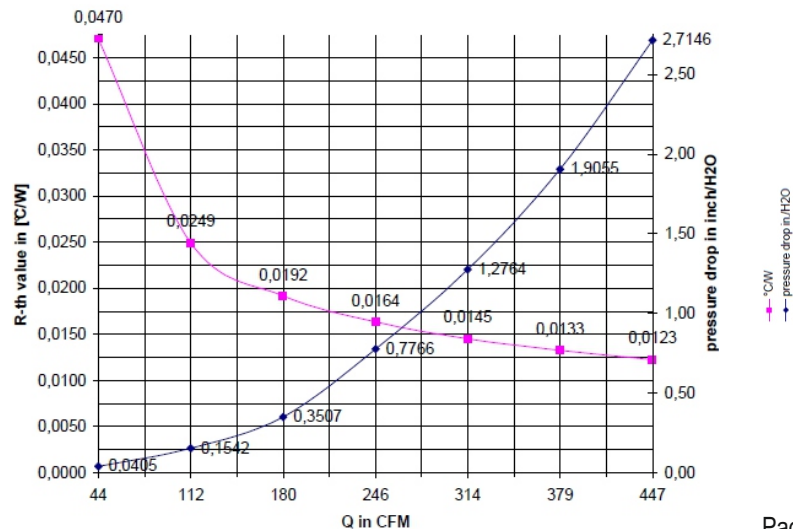

I valori espressi dalle curve sono puramente indicativi
 AGGIORNAMENTO CONTINUO - ED. DEL 02-2017
 -RIPRODUZIONE VIETATA-

Via Newton, n.12
 20016 Pero (Milano - Italy)
 Tel. +39 02 3535955 r.a. Fax. +39 02 3539929
 E-Mail: info@omar-alluminio.it

Cataloghi Online: www.omar-alluminio.it
www.omar-alluminio.com

PROFILATI ALLUMINIO A DISEGNO / STANDARD / SPECIALI / E PER:
 ELETTRONICA / LED / FOTOVOLTAICO / AUTOMAZIONE ROBOTICA / PNEUMATICA / AUTOMOTIVE



DISSIPATORI AD ALTO RENDIMENTO

DISEGNI META' DEL VERO (1:2)- SCALE 1:2

Via Newton, n. 12
20016 Pero (Milano - Italy)
Tel. +39 02 3535955 r.a. Fax. +39 02 3539929
E. Mail: info@omar-alluminio.it

Cataloghi Online: www.omar-alluminio.it
www.omar-alluminio.com
PROFILATI ALLUMINIO A DISEGNO / STANDARD / SPECIALI / E PER:
ELETTRONICA / LED / FOTOVOLTAICO / AUTOMAZIONE ROBOTICA / PNEUMATICA / AUTOMOTIVE

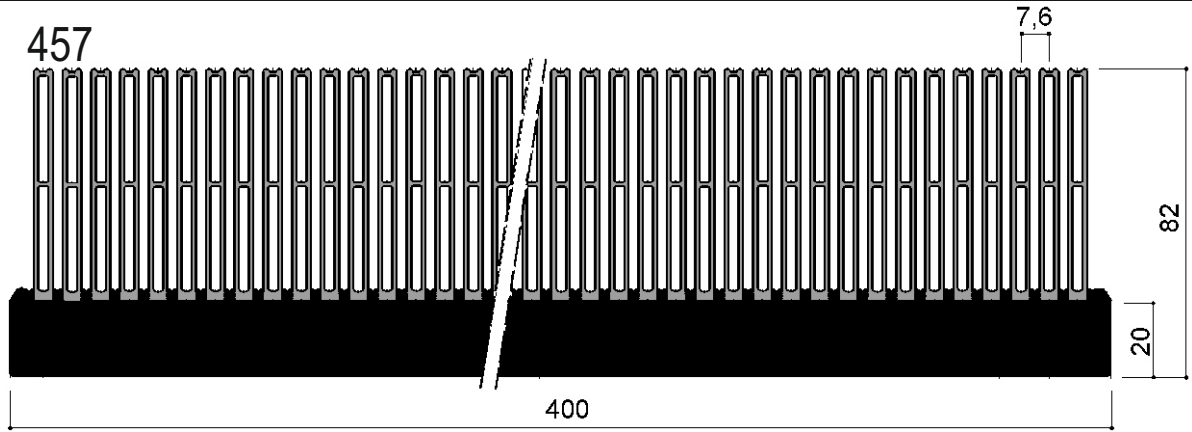

Resistenza termica (KW) in ventilazione forzata

Lg. (mm)	200	300	400	500
R _{th} a 11m/s	0,00 161	0,0128	0,01 09	0,0097

length 11.81 in. [300mm]



FOTO DI ESEMPIO: TAGLIO A MISURA DI DISSIPATORI "FLOWER" ANCHE DI GROSSE DIMENSIONI



Resistenza termica (KW) in ventilazione forzata

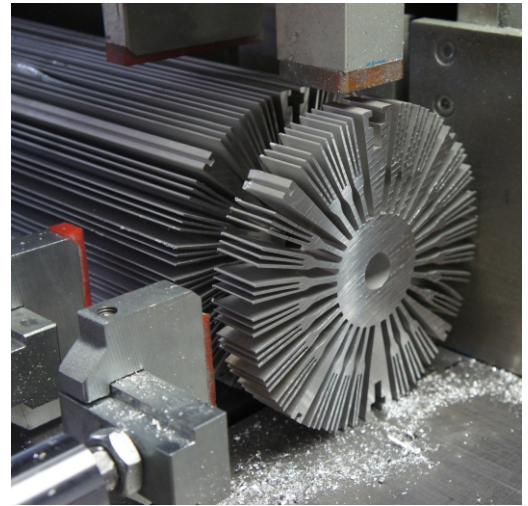
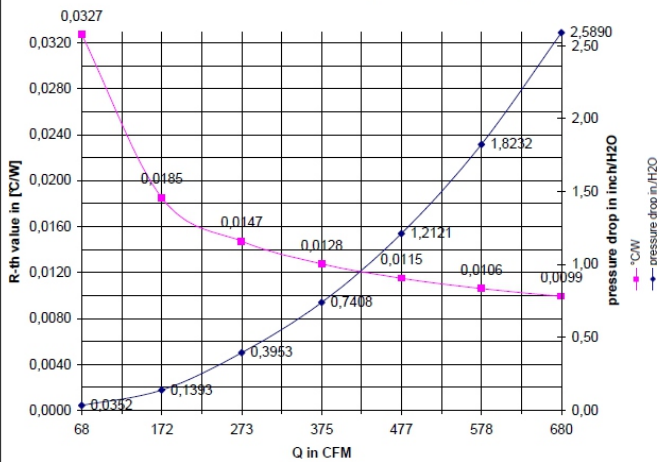
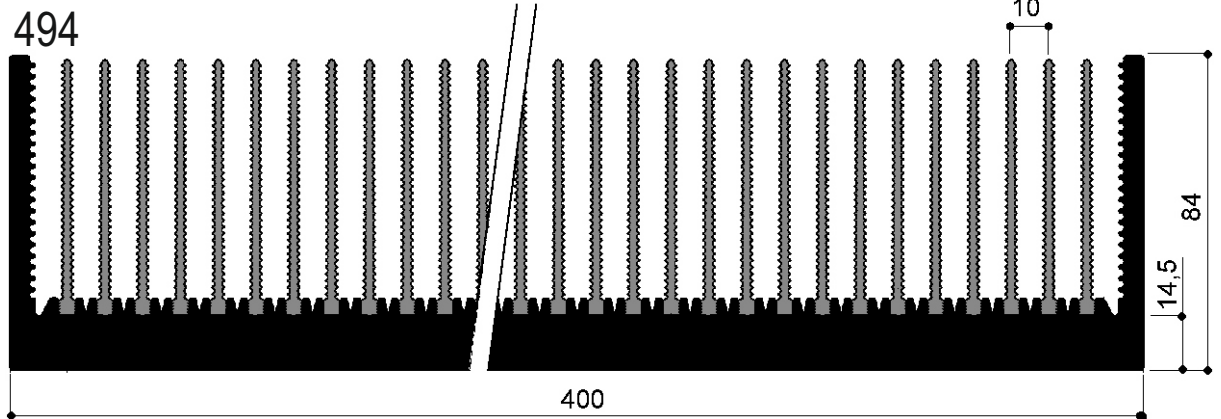
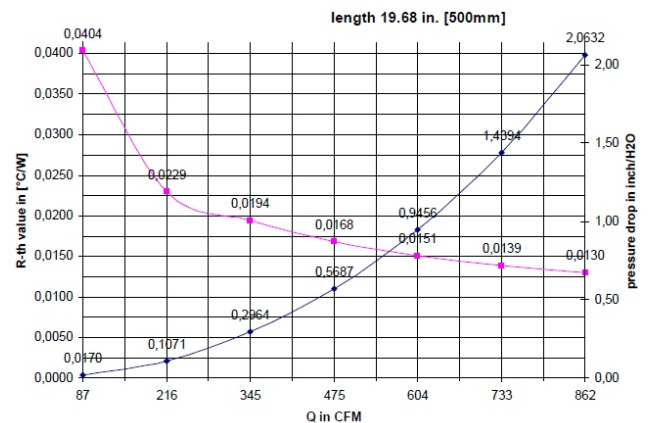

DISSIPATORI AD ALTO RENDIMENTO

DISEGNI META' DEL VERO (1:2)- SCALE 1:2

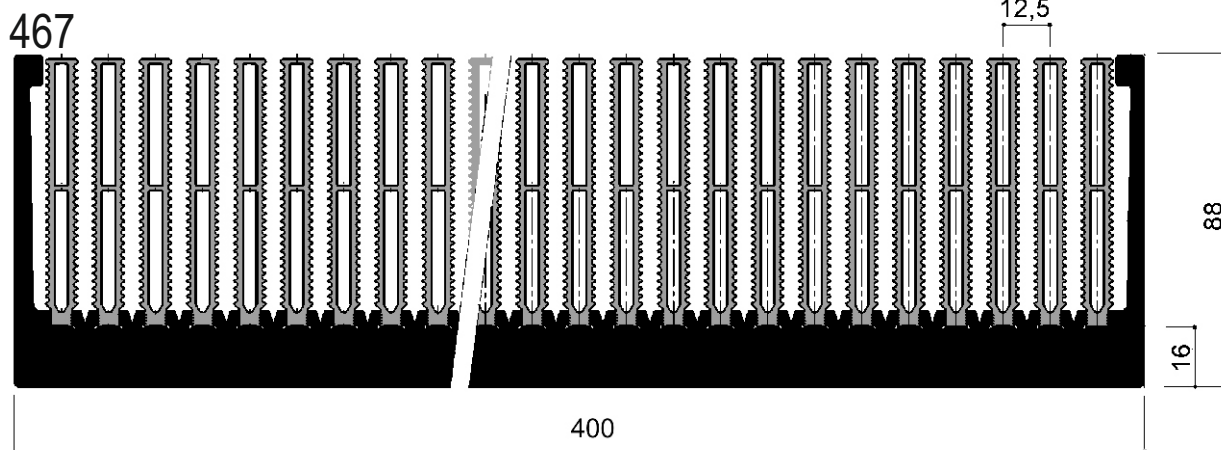

Resistenza termica (K/W) in ventilazione forzata

Lg. (mm)	100	200	300
R _{th} a 5m/s	0,036	0,026	0,019

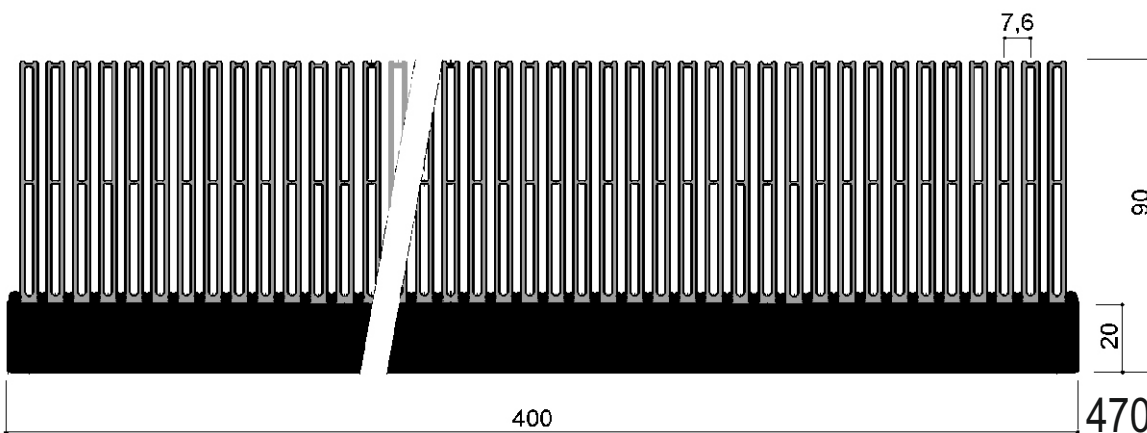
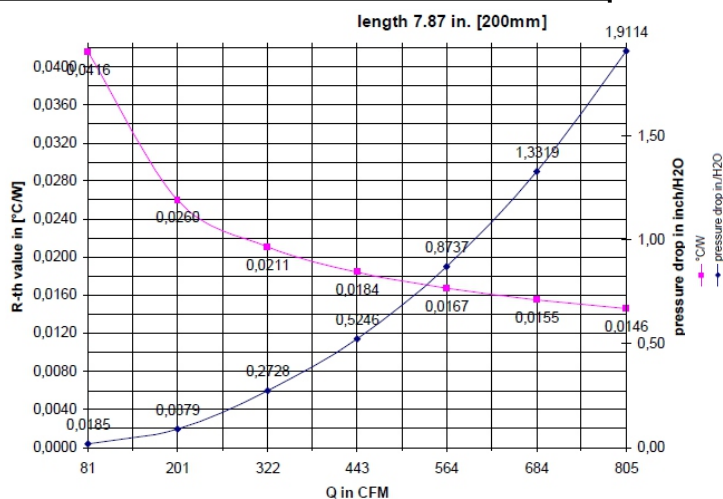

Resistenza termica (K/W) in ventilazione forzata

Lg. (mm)	200	300	400	500
R _{th} a 11m/s	0,0145	0,0115	0,0098	0,0087



FOTO DI ESEMPIO: TAGLIO PROFILO IN ALLUMINIO ESTRUSO PER LED DI GROSSE DIMENSIONI

Via Newton, n.12
20016 Pero (Milano - Italy)
Tel. +39 02 3535955 r.a. Fax. +39 02 3539929
E-Mail: info@omar-alluminio.it

Cataloghi Online: www.omar-alluminio.it
www.omar-alluminio.com

PROFILATI ALLUMINIO A DISEGNO / STANDARD / SPECIALI / E PER:
ELETTRONICA / LED / FOTOVOLTAICO / AUTOMAZIONE ROBOTICA / PNEUMATICA / AUTOMOTIVE

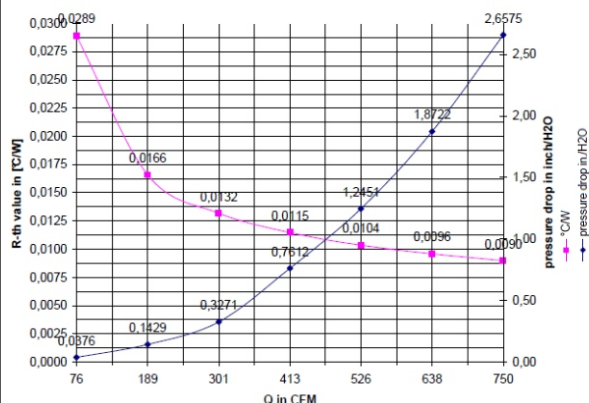

DISSIPATORI AD ALTO RENDIMENTO

DISEGNI META' DEL VERO (1:2)- SCALE 1:2

Via Newton, n.12
20016 Pero (Milano - Italy)
Tel. +39 02 3535955 r.a. Fax. +39 02 3539929
E. Mail: info@omar-alluminio.it

Cataloghi Online: www.omar-alluminio.it
www.omar-alluminio.com
PROFILATI ALLUMINIO A DISEGNO / STANDARD / SPECIALI / E PER:
ELETTRONICA / LED / FOTOVOLTAICO / AUTOMAZIONE ROBOTICA / PNEUMATICA / AUTOMOTIVE

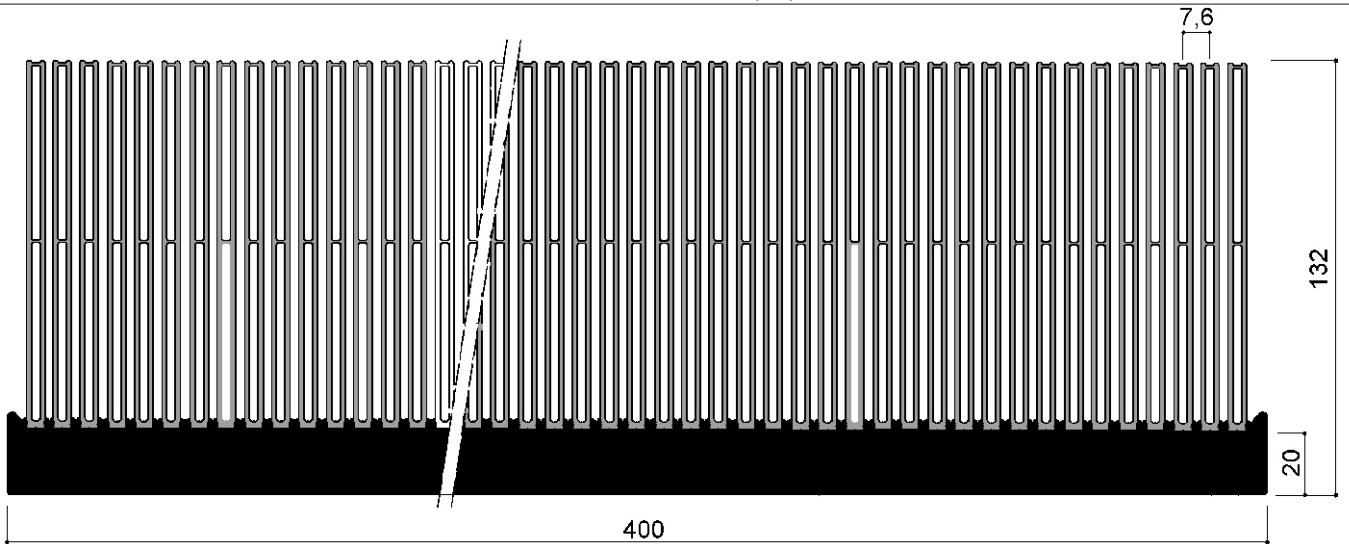

474

length 11.81 in. [300mm]

Resistenza termica (K/W) in ventilazione forzata

Lg. (mm)	200	300	400	500
R _{th} a 5m/s	0,0121	0,0092	0,0077	0,0067

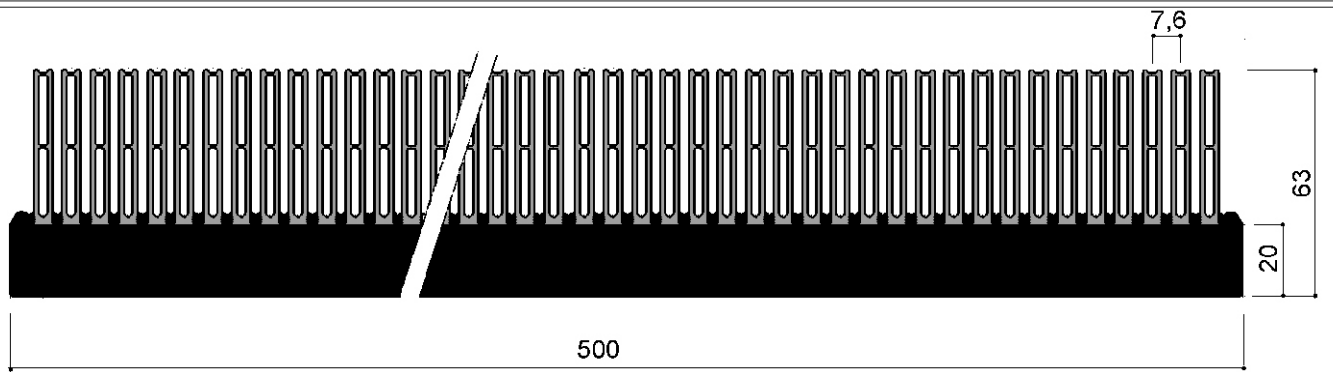
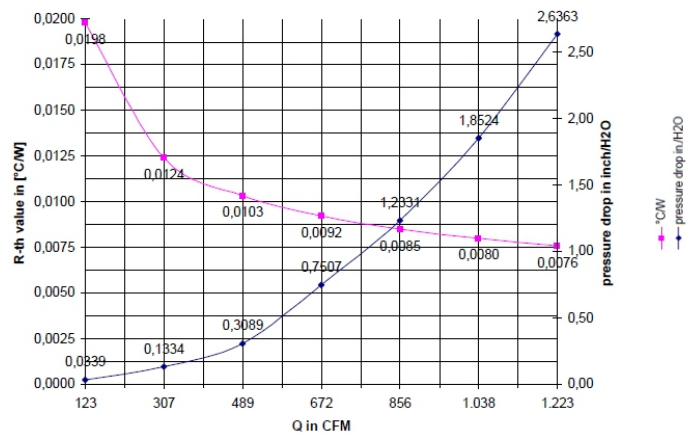

472

length 15.74 in. [400mm]

Resistenza termica (K/W) in ventilazione forzata

Lg. (mm)	200	300	400	500
R _{th} a 11 m/s	0,0162	0,0131	0,0114	0,0103

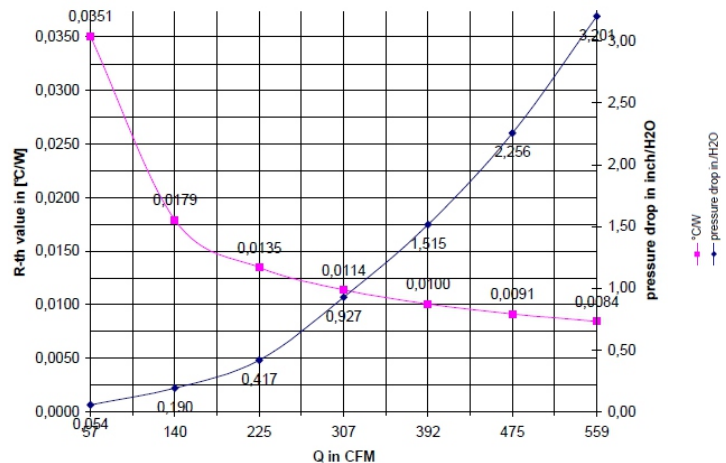

DISSIPATORI AD ALTO RENDIMENTO



DISEGNI META' DEL VERO (1:2)- SCALE 1:2

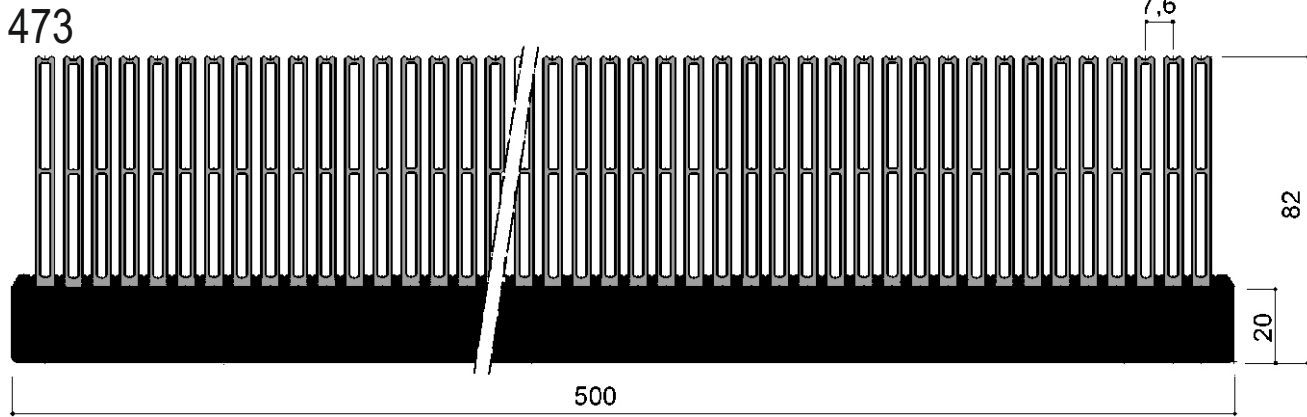

Resistenza termica (KW) in ventilazione forzata

Lg. (mm)	200	300	400	500
R _{th} a 5m/s	0,0129	0,0102	0,0087	0,0077

length 11.81 in. [300mm]

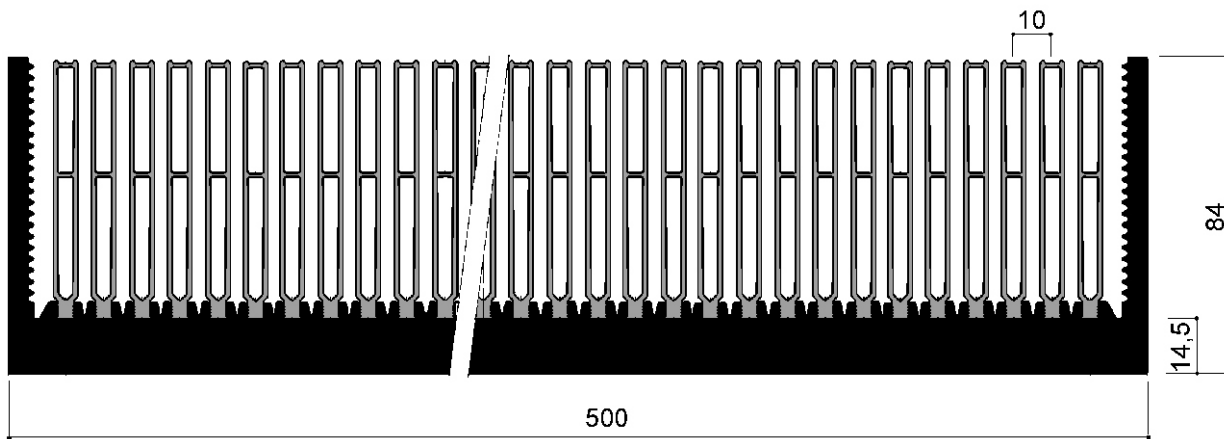
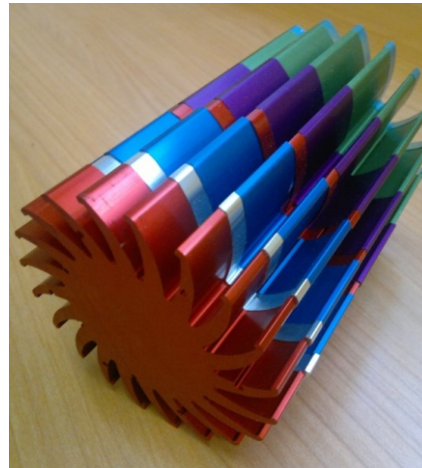
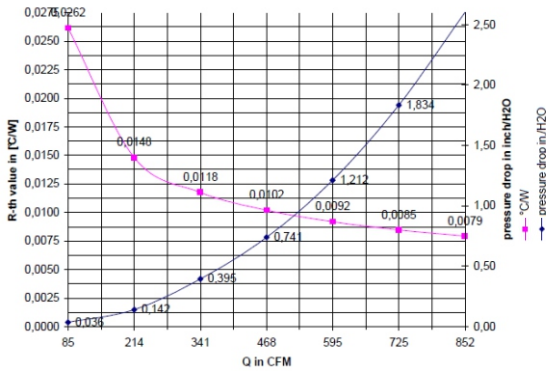

461

length 15.74 in. [400mm]

Resistenza termica (KW) in ventilazione forzata

Lg. (mm)	100	200	300	400	500
R _{th} a 5m/s	0,0324	0,0215	0,0171	0,0147	0,0131

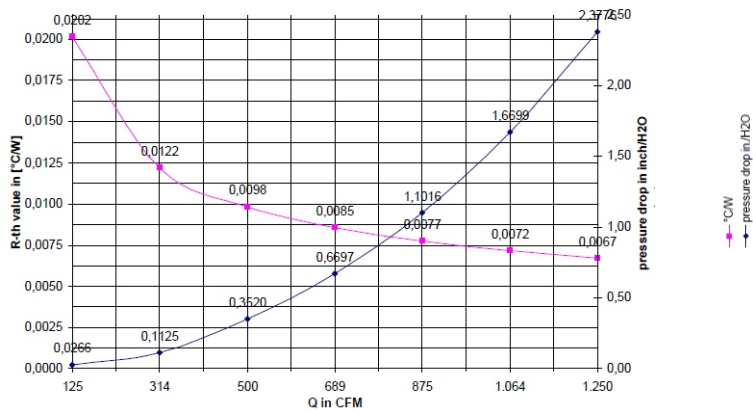

Cataloghi Online: www.omar-alluminio.it
www.omar-alluminio.com

PROFILATI ALLUMINIO A DISEGNO / STANDARD / SPECIALI / E PER:
 ELETTRONICA / LED / FOTOVOLTAICO / AUTOMAZIONE ROBOTICA / PNEUMATICA / AUTOMOTIVE



Via Newton, n.12
 20016 Pero (Milano - Italy)
 Tel. +39 02 3535955 r.a. Fax. +39 02 3539929
 E-Mail: info@omar-alluminio.it

DISSIPATORI AD ALTO RENDIMENTO



DISEGNI META' DEL VERO (1:2)- SCALE 1:2

Via Newton, n.12
20016 Pero (Milano - Italy)
Tel. +39 02 3535955 r.a. Fax. +39 02 3539929
E. Mail: info@omar-alluminio.it

Cataloghi Online: www.omar-alluminio.it
www.omar-alluminio.com
PROFILATI ALLUMINIO A DISEGNO / STANDARD / SPECIALI / E PER:
ELETTRONICA / LED / FOTOVOLTAICO / AUTOMAZIONE ROBOTICA / PNEUMATICA / AUTOMOTIVE

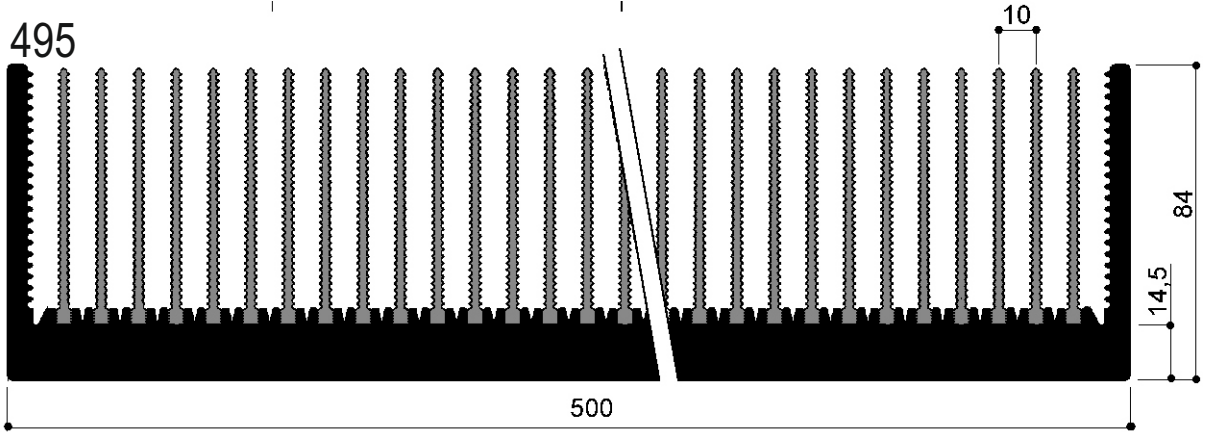

Resistenza termica (KW) in ventilazione forzata

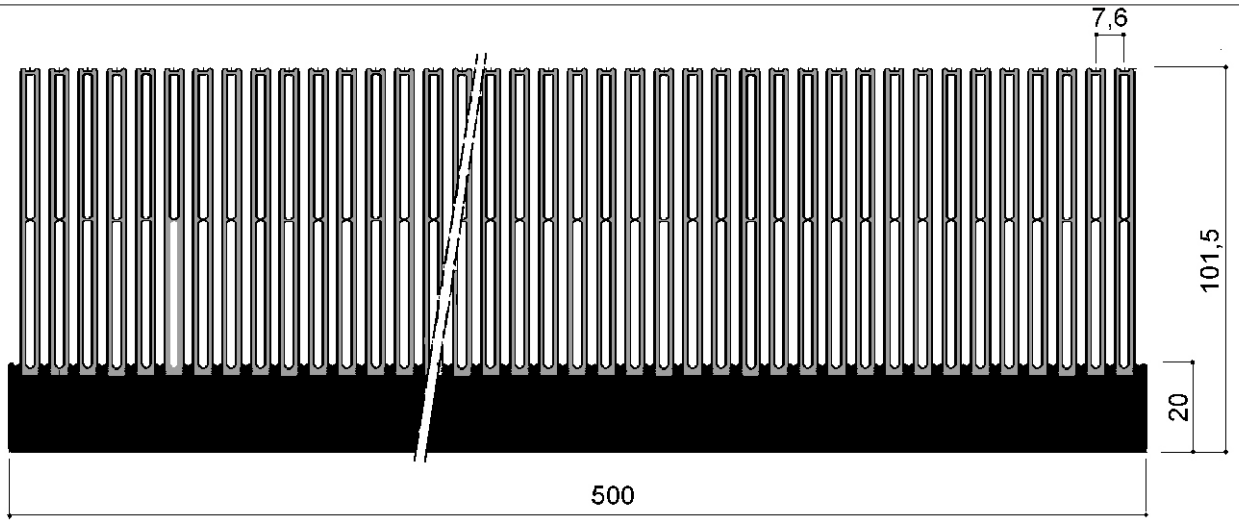
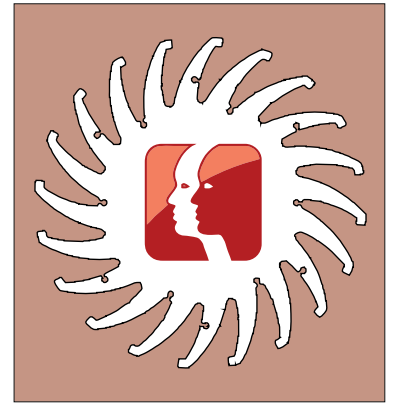
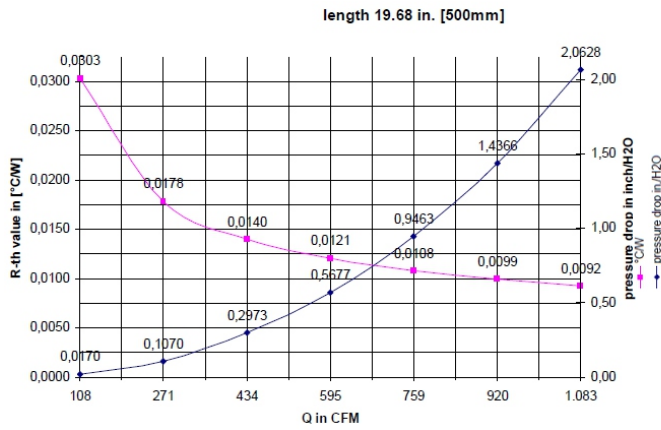

Resistenza termica (KW) in ventilazione forzata

Lg. (mm)	200	300	400	500
R _{th} a 11 m/s	0,0109	0,0085	0,0072	0,0063

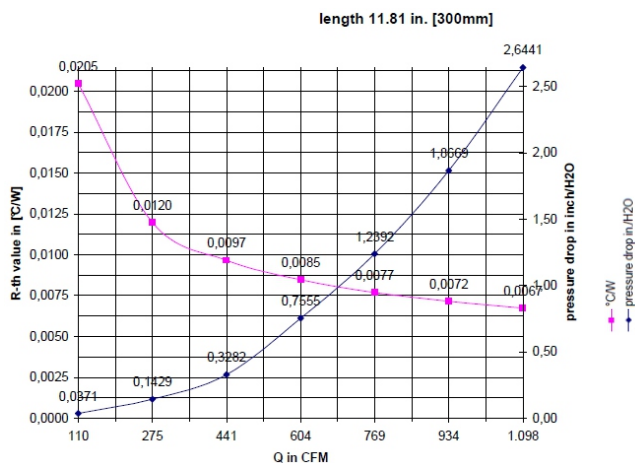

DISSIPATORI AD ALTO RENDIMENTO

DISEGNI META' DEL VERO (1:2)- SCALE 1:2

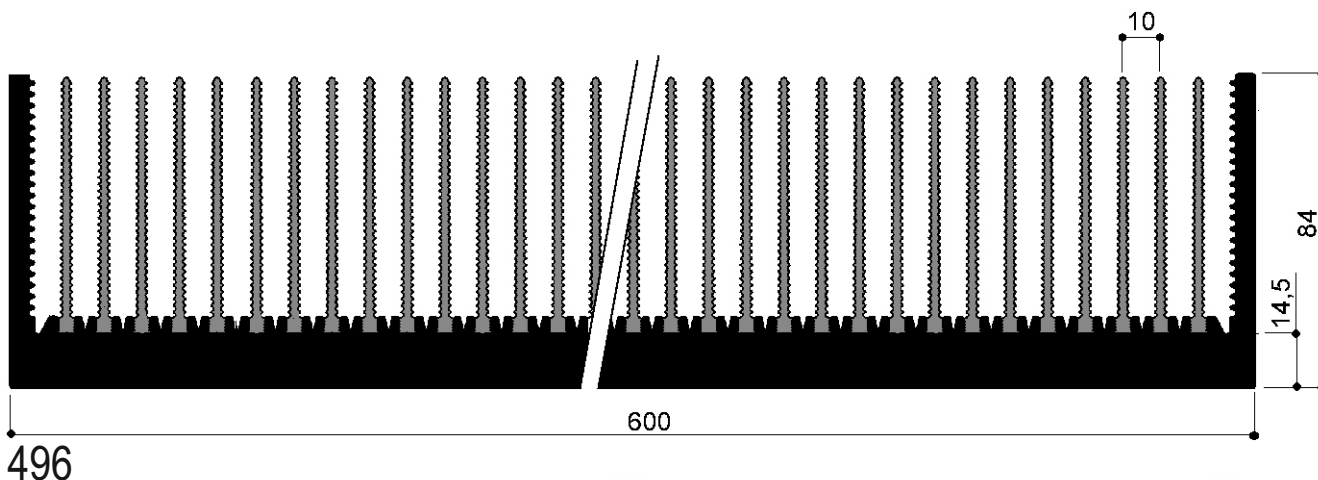
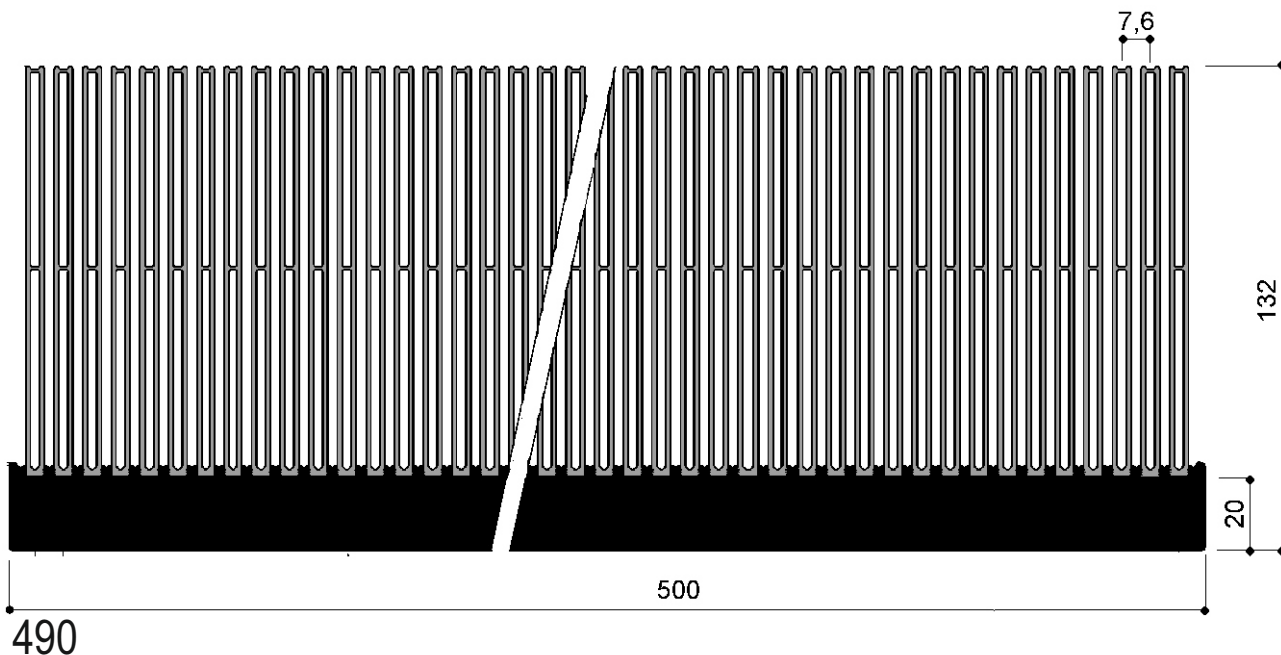

Resistenza termica (K/W) in ventilazione forzata

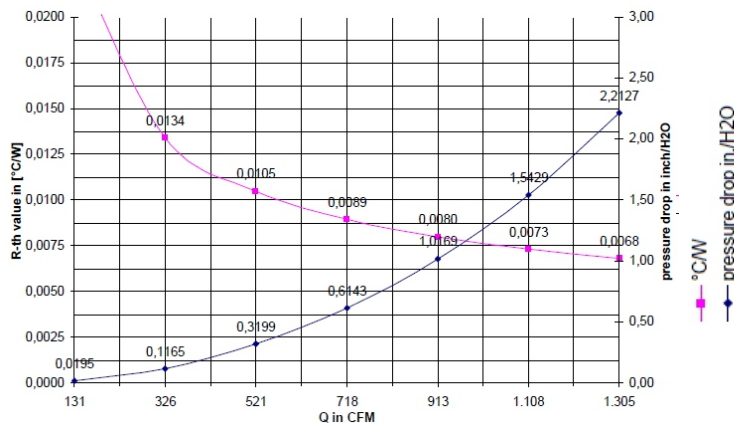

Via Newton, n.12

20016 Pero (Milano - Italy)

Tel. +39 02 3535955 r.a. Fax. +39 02 3539929

E-Mail: info@omar-alluminio.it

Cataloghi Online: www.omar-alluminio.it

www.omar-alluminio.com

PROFILATI ALLUMINIO A DISEGNO / STANDARD / SPECIALI / E PER:

ELETTRONICA / LED / FOTOVOLTAICO / AUTOMAZIONE ROBOTICA / PNEUMATICA / AUTOMOTIVE

OMAR s.p.a.
PROFILATI ALLUMINIO
ALTA TECNOLOGIA



DISSIPATORI AD ALTO RENDIMENTO

DISEGNI META' DEL VERO (1:2)- SCALE 1:2



Via Newton, n.12
20016 Pero (Milano - Italy)
Tel. +39 02 3535955 r.a. Fax. +39 02 3539929
E.Mail: info@omar-alluminio.it

Cataloghi Online: www.omar-alluminio.it
www.omar-alluminio.com

PROFILATI ALLUMINIO A DISEGNO / STANDARD / SPECIALI / E PER:
ELETTRONICA / LED / FOTOVOLTAICO / AUTOMAZIONE ROBOTICA / PNEUMATICA / AUTOMOTIVE

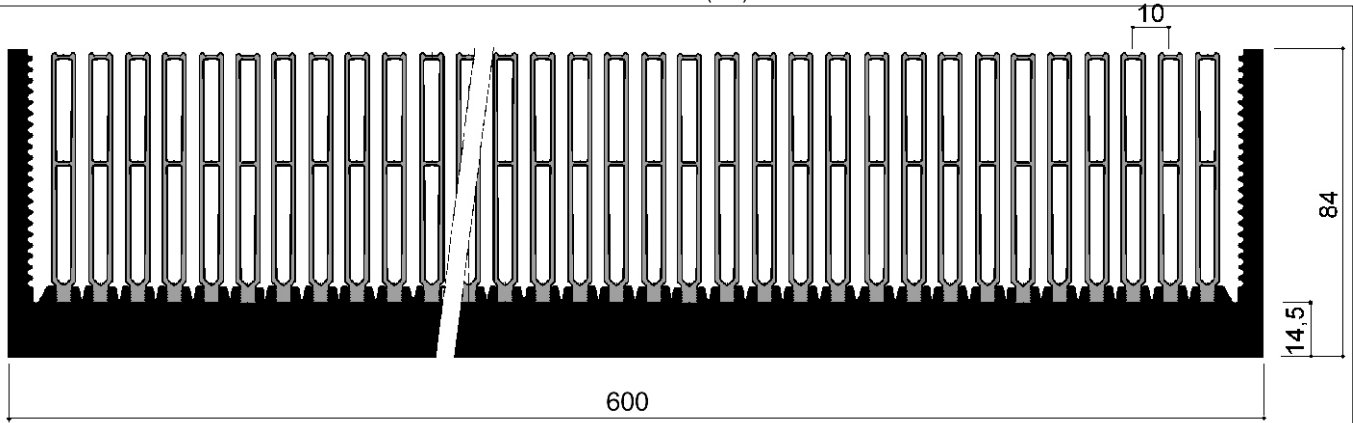

468

Resistenza termica (KW) in ventilazione forzata

Lg. (mm)	100	200	300	400	500	600
R _{th} a 11 m/s	0,0269	0,0178	0,0142	0,0122	0,0109	0,0100

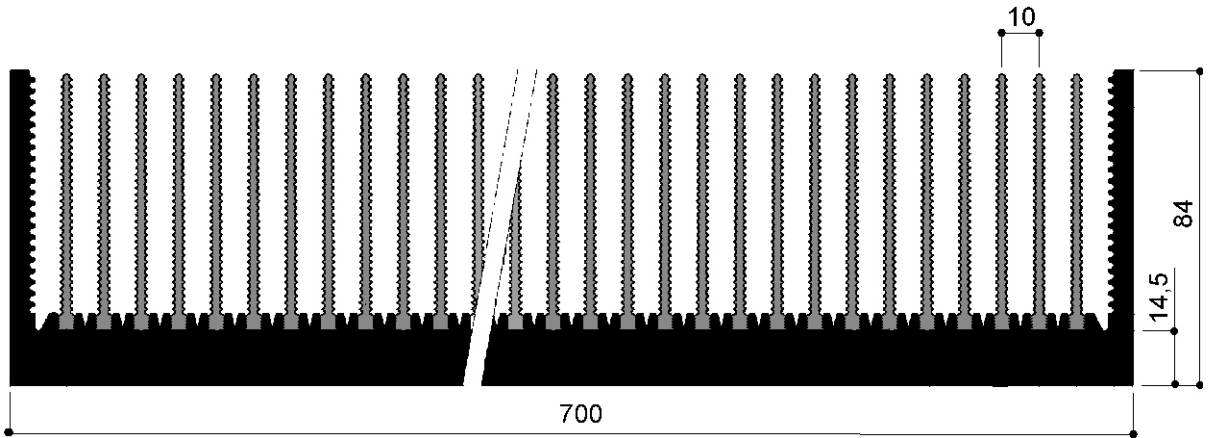
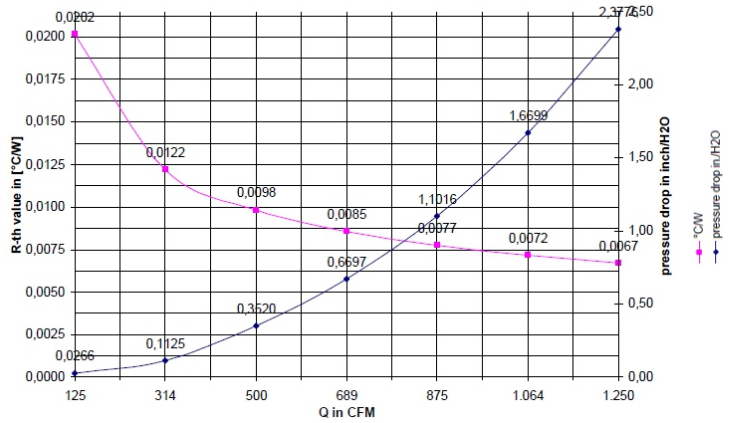

497

Resistenza termica (KW) in ventilazione forzata

Lg. (mm)	200	300	400	500	600	700
R _{th}	0,0210	0,0168	0,0143	0,0121	0,0107	0,0099

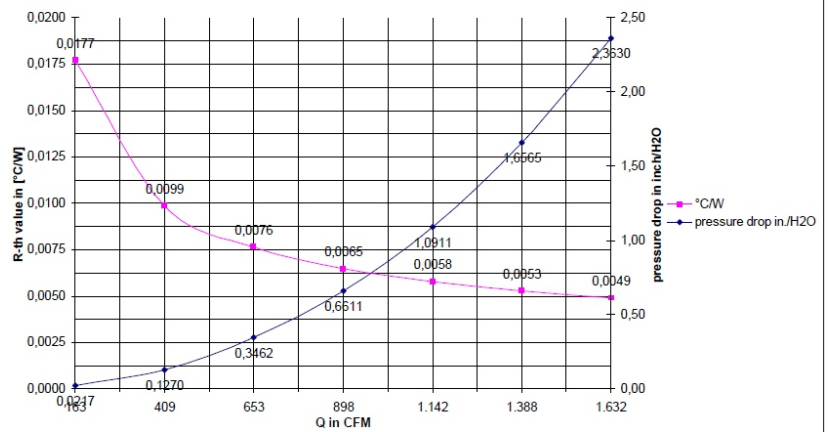

DISSIPATORI AD ALTO RENDIMENTO

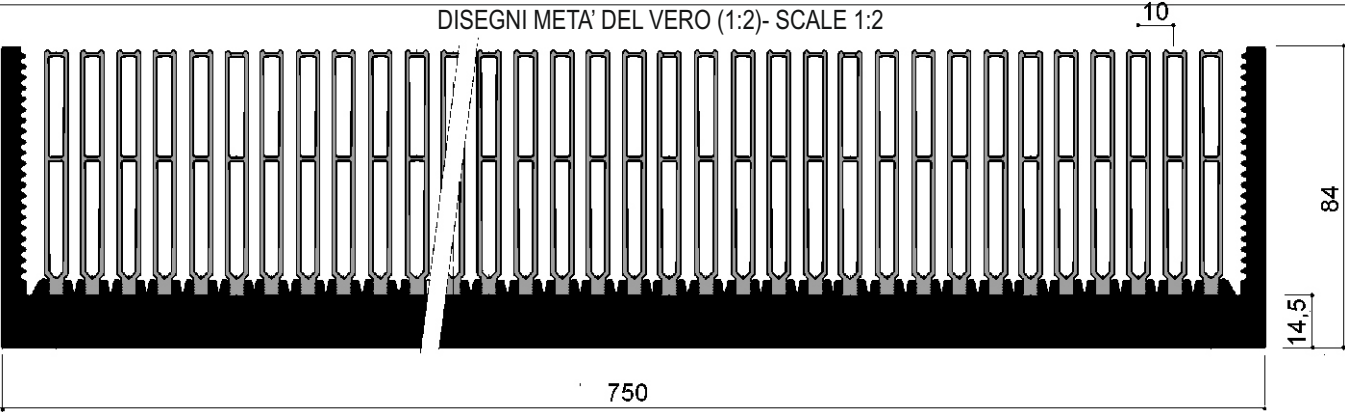

469

length 19.68 in. [500mm]

Resistenza termica (KW) in ventilazione forzata

Lg. (mm)	200	300	400	500	600	700
R _n a 5m/s	0,0142	0,0113	0,0097	0,0087	0,008	0,0074

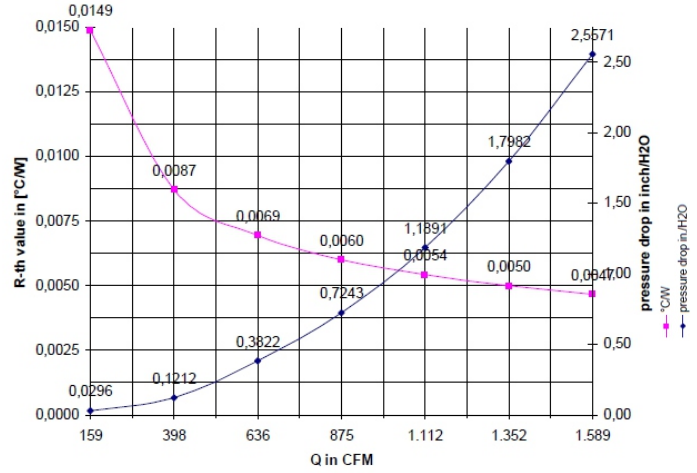

I valori espressi dalle curve sono puramente indicativi

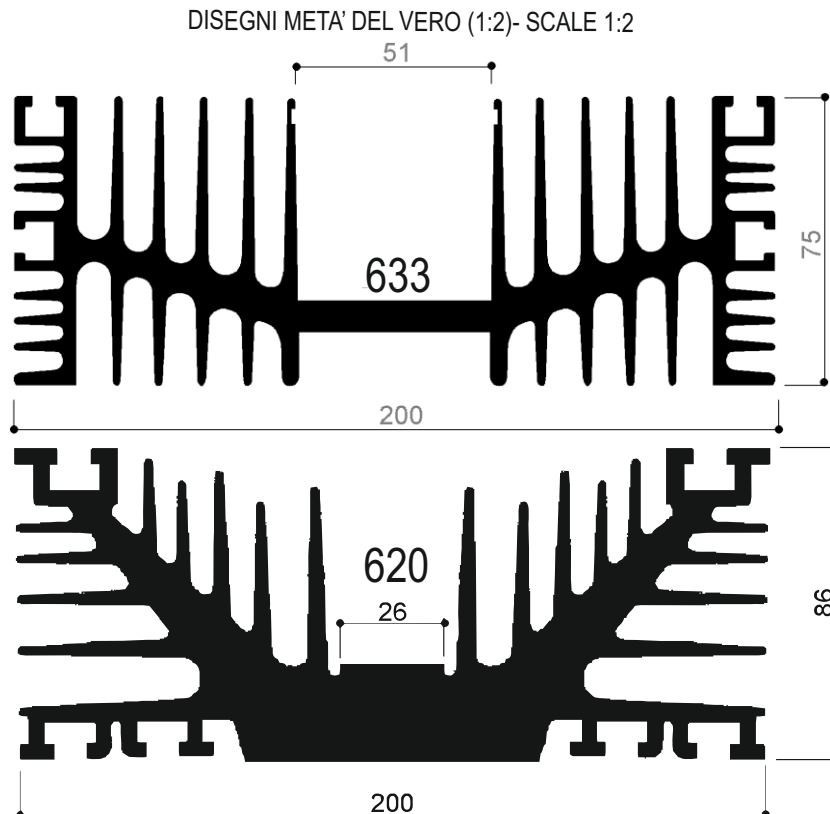

DISEGNI META' DEL VERO (1:2)- SCALE 1:2

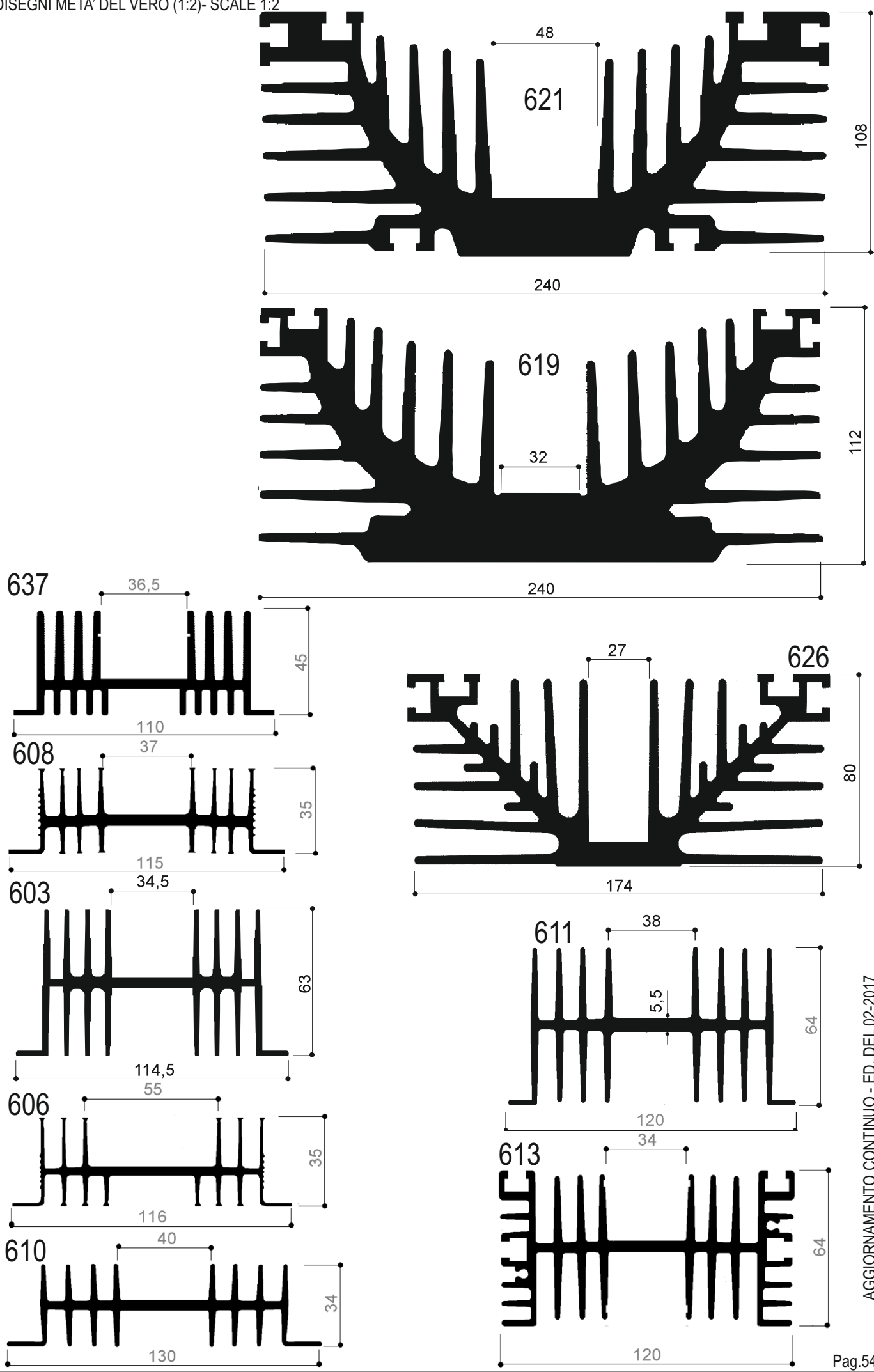

DISEGNI META' DEL VERO (1:2)- SCALE 1:2

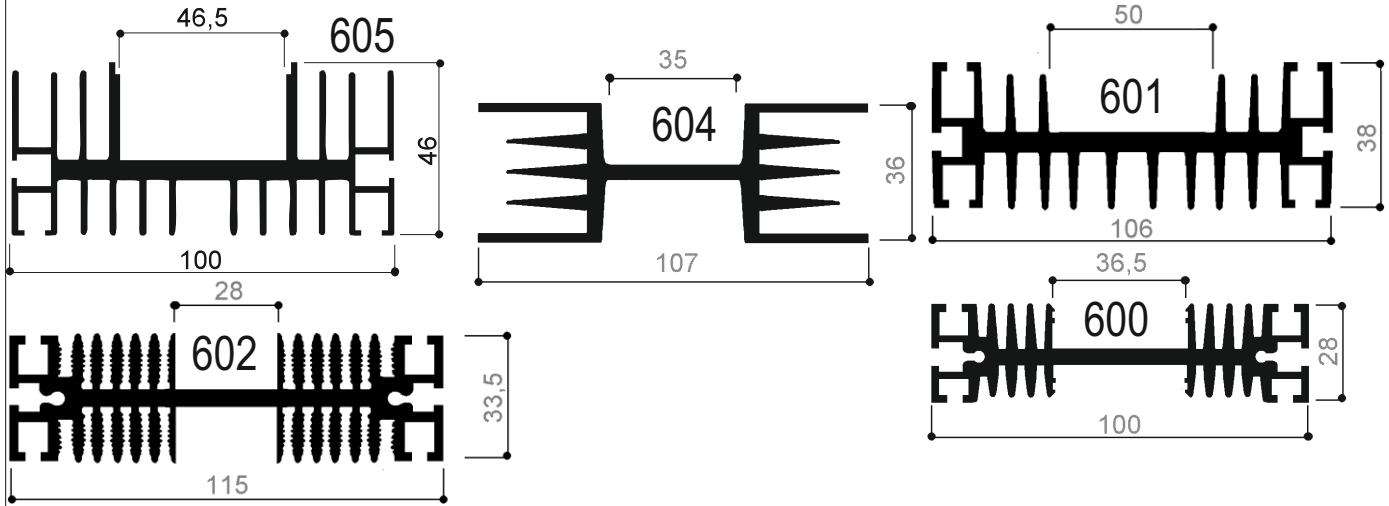

SISTEMI DI RADIAZIONE
A VENTILAZIONE FORZATA
COOLING AGGREGATES

913

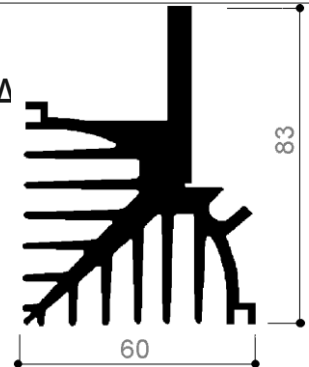
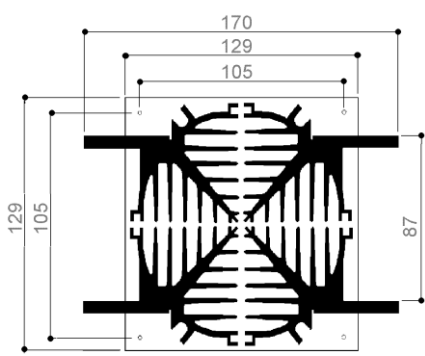

DISEGNI META' DEL VERO (1:2)- SCALE 1:2

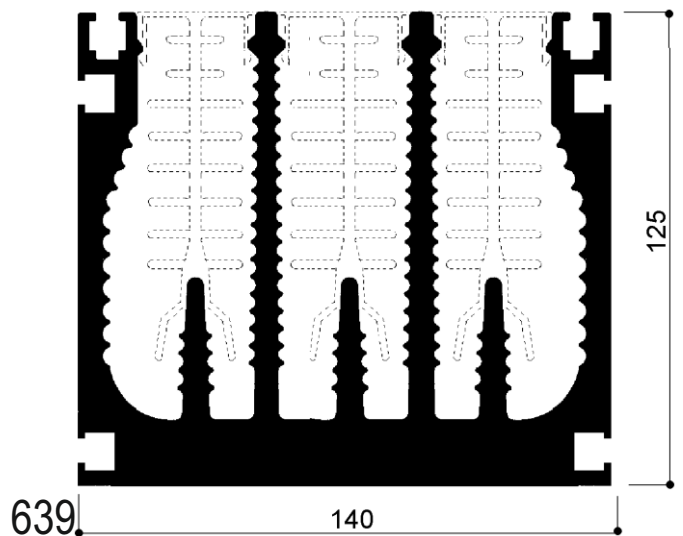
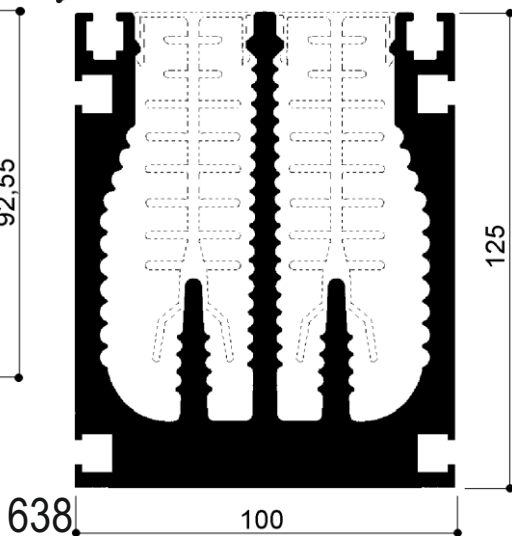
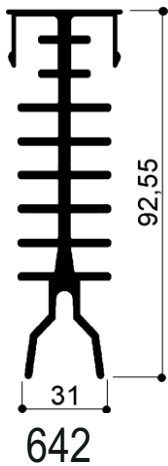
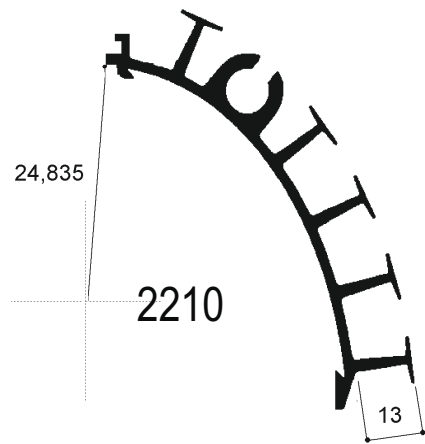
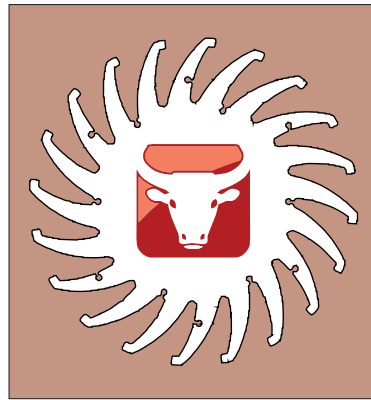
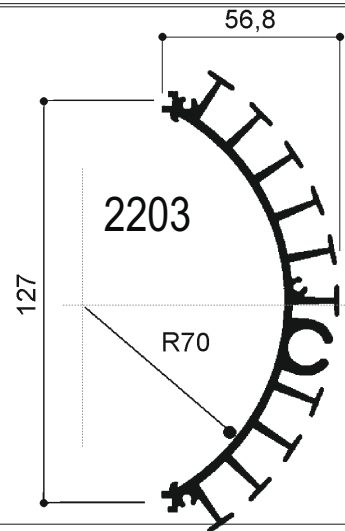

Via Newton, n.12
20016 Pero (Milano - Italy)
Tel. +39 02 3535955 r.a. Fax. +39 02 3539929
E-Mail: info@omar-alluminio.it

Cataloghi Online: www.omar-alluminio.it
www.omar-alluminio.com
PROFILATI ALLUMINIO A DISEGNO / STANDARD / SPECIALI / E PER:
ELETTRONICA / LED / FOTOVOLTAICO / AUTOMAZIONE ROBOTICA / PNEUMATICA / AUTOMOTIVE



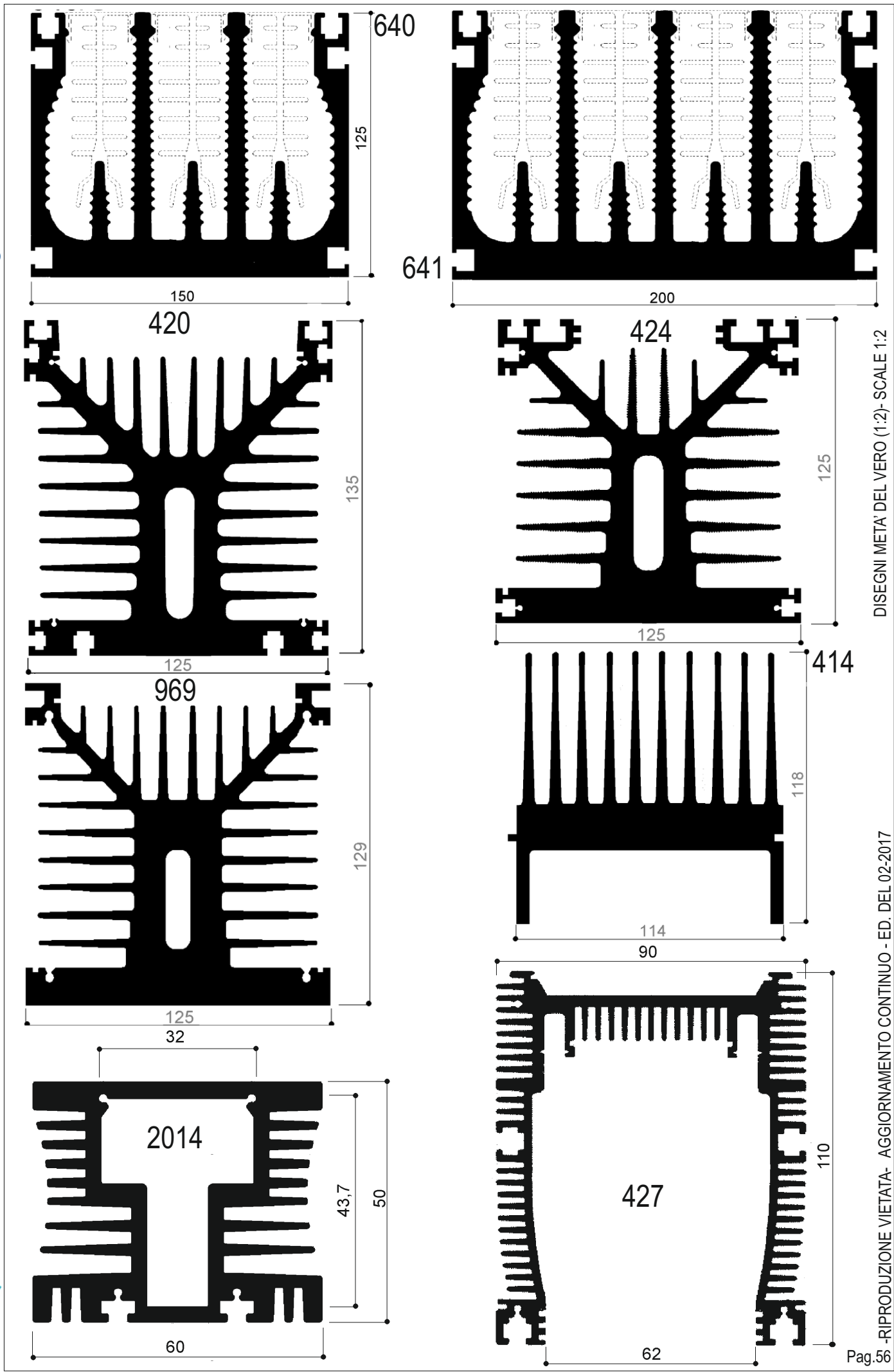

Dissipatori di calore in alluminio per illuminazione a Led

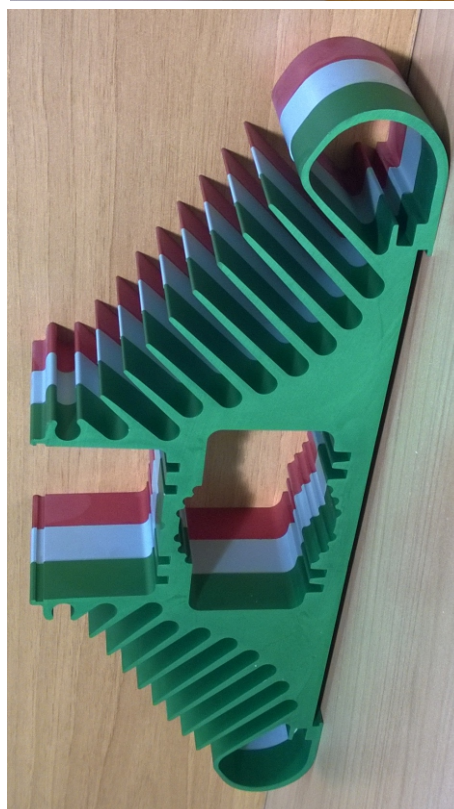
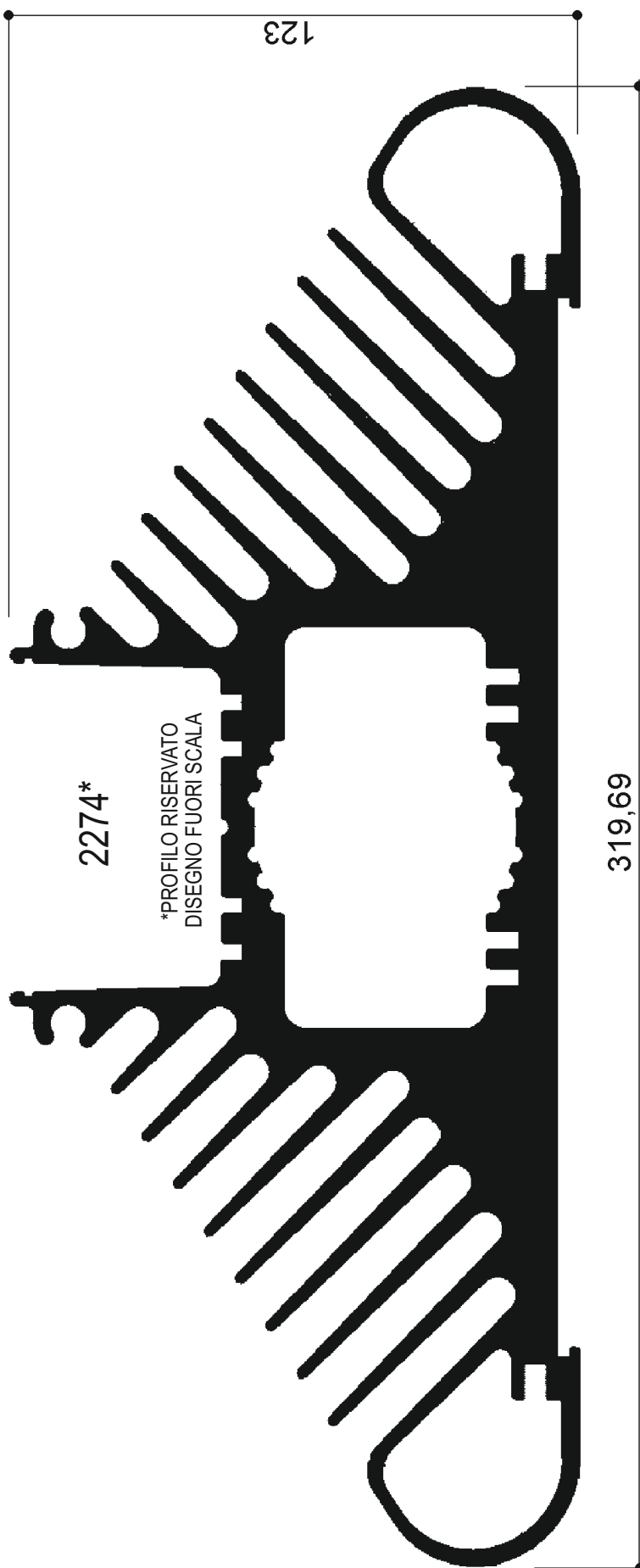

Cataloghi Online: www.omar-alluminio.it
www.omar-alluminio.com

PROFILATI ALLUMINIO A DISEGNO / STANDARD / SPECIALI / E PER:
ELETTRONICA / LED / FOTOVOLTAICO / AUTOMAZIONE ROBOTICA / PNEUMATICA / AUTOMOTIVE

Via Newton, n.12
20016 Pero (Milano - Italy)
Tel. +39 02 3535955 r.a. Fax. +39 02 3539929
E-Mail: info@omar-alluminio.it

Dissipatori di calore in alluminio per illuminazione a Led



Cataloghi Online: www.omar-alluminio.it

www.omar-alluminio.com

PROFILATI ALLUMINIO A DISEGNO / STANDARD / SPECIALI / E PER:

ELETTRONICA / LED / FOTOVOLTAICO / AUTOMAZIONE ROBOTICA / PNEUMATICA / AUTOMOTIVE

Via Newton, n.12

20016 Pero (Milano - Italy)

Tei. +39 02 3535955 r.a. Fax. +39 02 3539929

E.Mai: info@omar-alluminio.it



2271*

*PROFILO RISERVATO
DISEGNO FUORI SCALA

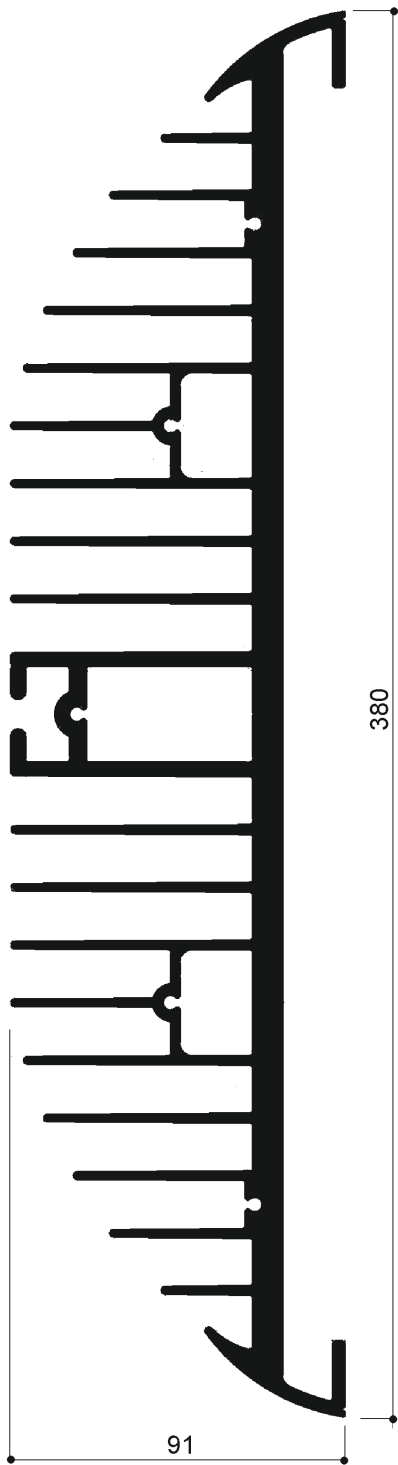

2017*

*PROFILO RISERVATO
DISEGNO FUORI SCALA

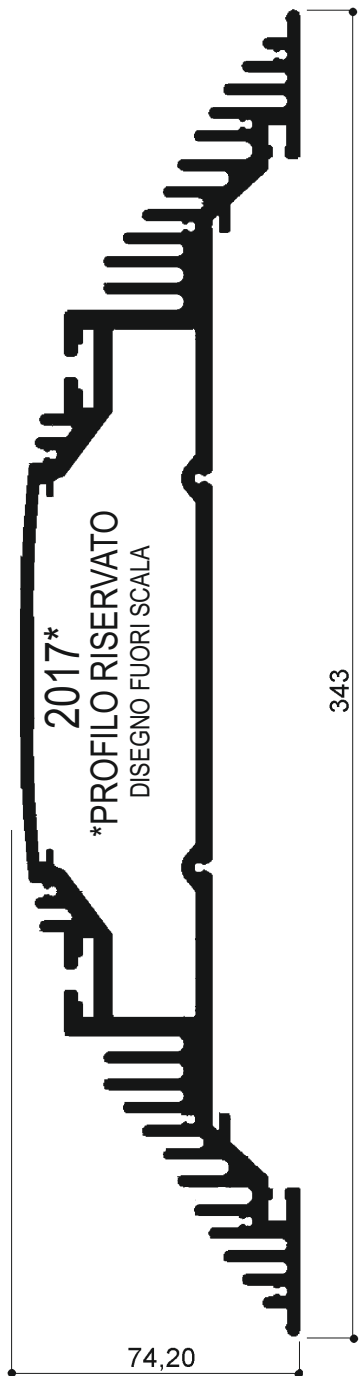

956

DISEGNO FUORI SCALA

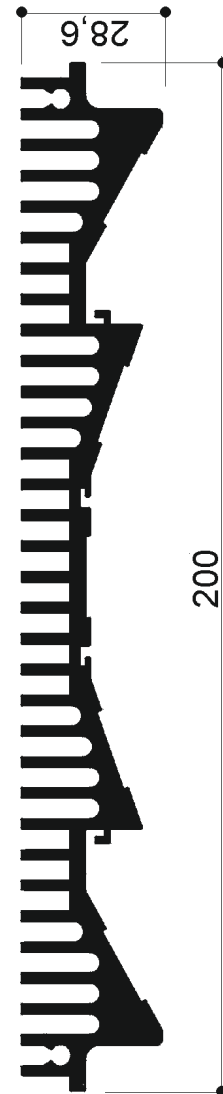

Dissipatori di calore in alluminio per illuminazione a Led



*PROFILO RISERVATO DISEGNO FUORI SCALA

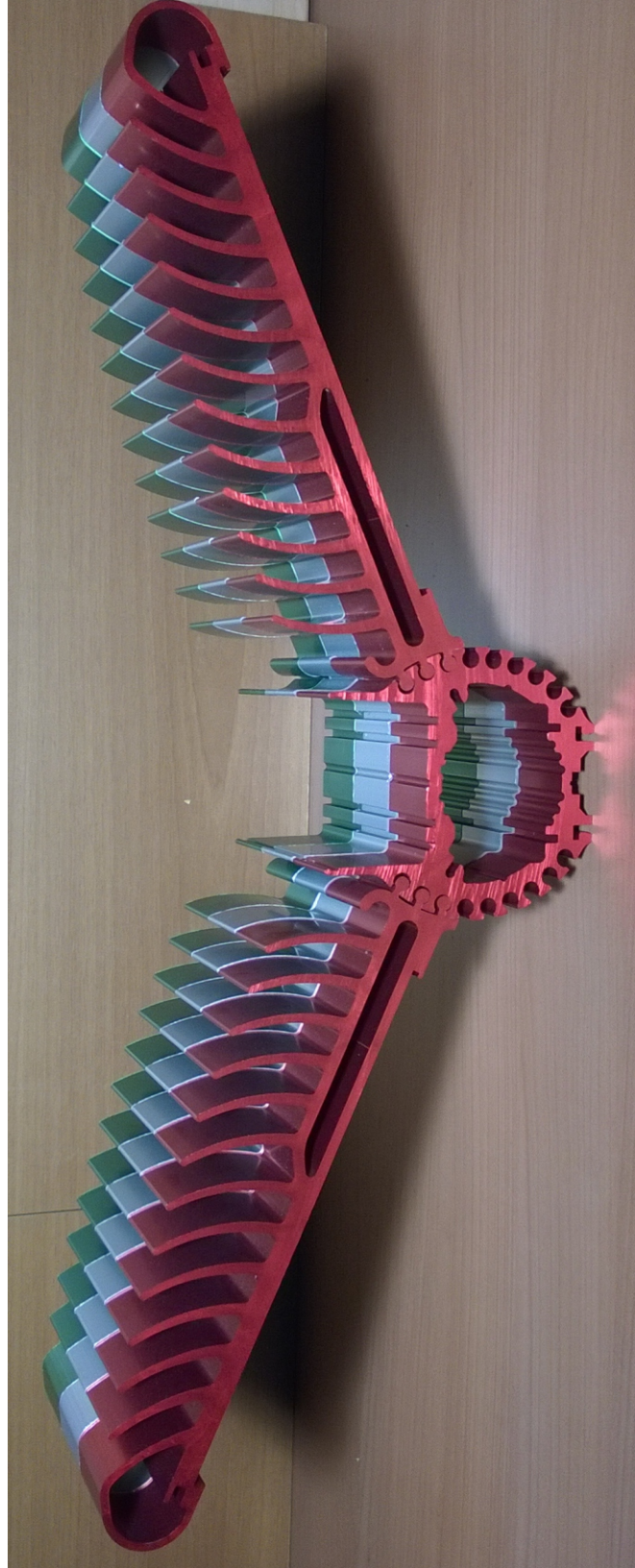
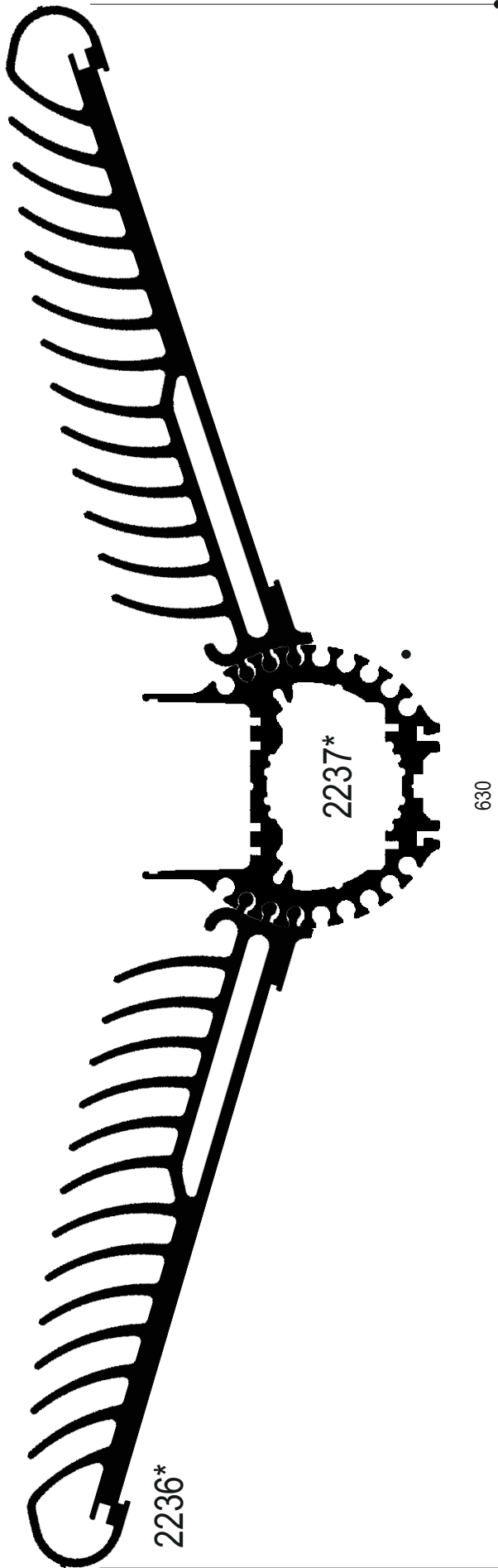

Cataloghi Online: www.omar-alluminio.it

www.omar-alluminio.com

PROFILATI ALLUMINIO A DISEGNO / STANDARD / SPECIALI / E PER:

ELETTRONICA / LED / FOTOVOLTAICO / AUTOMAZIONE ROBOTICA / PNEUMATICA / AUTOMOTIVE



Via Newton, n.12

20016 Pero (Milano - Italy)

Tel. +39 02 3535955 r.a. Fax. +39 02 3539929

E-Mail: info@omar-alluminio.it

Dissipatori di calore in alluminio per illuminazione a Led



DISEGNO FUORI SCALA

*DISEGNO A DISEGNATO

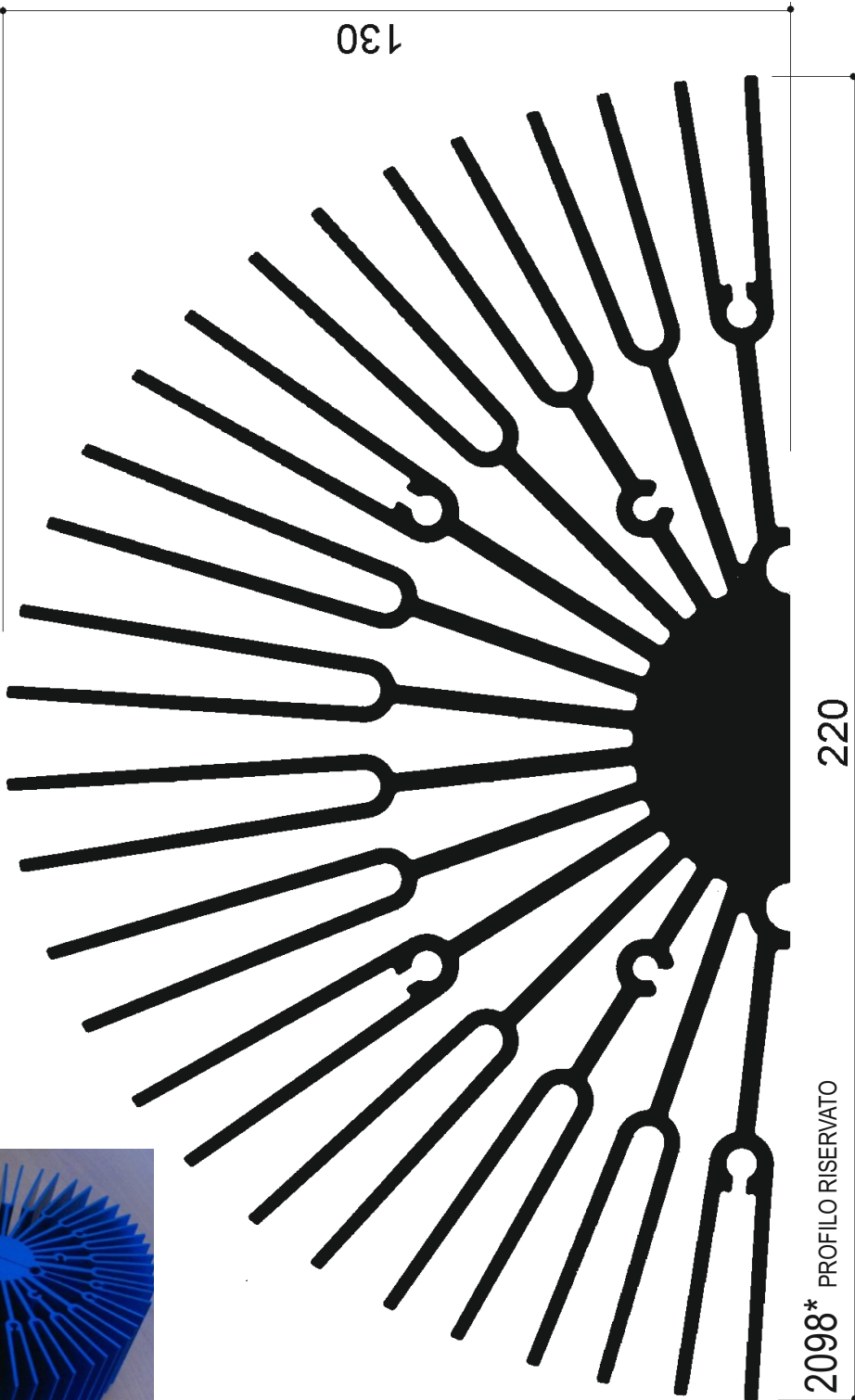

Via Newton, n.12

20016 Pero (Milano - Italy)

Tel. +39 02 3535955 r.a. Fax. +39 02 3539929

E-Mail: info@omar-alluminio.it

Cataloghi Online: www.omar-alluminio.it

www.omar-alluminio.com

PROFILATI ALLUMINIO A DISEGNO / STANDARD / SPECIALI / E PER:

ELETRONICA / LED / FOTOVOLTAICO / AUTOMAZIONE ROBOTICA / PNEUMATICA / AUTOMOTIVE



Dissipatori di calore in alluminio per illuminazione a Led

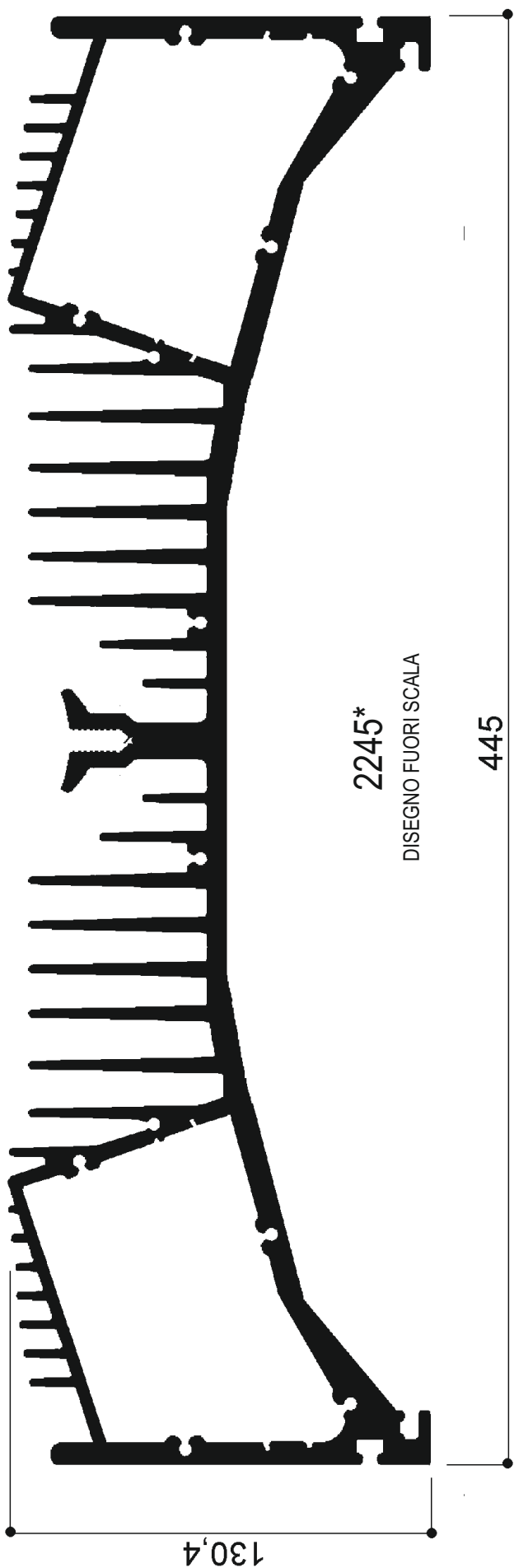

2245*

DISEGNO FUORI SCALA

445

130,4

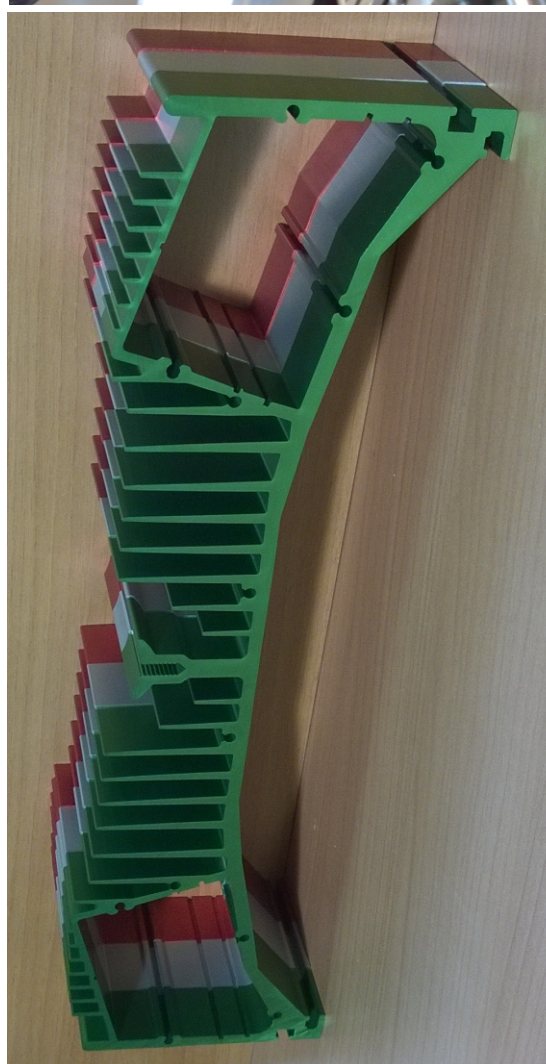

Cataloghi Online: www.omar-alluminio.it

www.omar-alluminio.com

PROFILATI ALLUMINIO A DISEGNO / STANDARD / SPECIALI / E PER:

ELETTRONICA / LED / FOTOVOLTAICO / AUTOMAZIONE ROBOTICA / PNEUMATICA / AUTOMOTIVE

Via Newton, n.12

20016 Pero (Milano - Italy)

Tel. +39 02 3535955 r.a. Fax. +39 02 3539929

E.Mail: info@omar-alluminio.it

Dissipatori di calore in alluminio per illuminazione a Led



Via Newton, n.12
20016 Pero (Milano - Italy)
Tel. +39 02 3535955 r.a. Fax. +39 02 3539929
E-Mail: info@omar-alluminio.it

Cataloghi Online: www.omar-alluminio.it
www.omar-alluminio.com

PROFILATI ALLUMINIO A DISEGNO / STANDARD / SPECIALI / E PER:
ELETTRONICA / LED / FOTOVOLTAICO / AUTOMAZIONE ROBOTICA / PNEUMATICA / AUTOMOTIVE



DISEGNI AL VERO SCALA 1:1

526

COV526

ESEMPIO PROFILI ASSEMBLATI

527

COV527

ESEMPIO PROFILI ASSEMBLATI

PIATTO BIADESIVO

COVER

528

COV528

ESEMPIO PROFILI ASSEMBLATI

PIATTO BIADESIVO

COVER

COV526 cover in policarbonato autoestinguente

COV526-PT: cover trasparente
COV526-PO: cover opale
COV526-PST: cover satinato trasparente
COV526-PSO: cover satinato opale

COV527 cover in policarbonato autoestinguente

COV527-PT: cover trasparente
COV527-PO: cover opale
COV527-PST: cover satinato trasparente
COV527-PSO: cover satinato opale

COV528 cover in policarbonato autoestinguente

COV528-PT: cover trasparente
COV528-PO: cover opale
COV528-PST: cover satinato trasparente
COV528-PSO: cover satinato opale
COV528-PTMIC: trasparente microprismato



COV533 cover in policarbonato autoestinguente

TAPPO CON FORO PASSACAVO IN ALLUMINIO ANODIZZATO PER ART.533 COD.ART.:L-0016

TAPPO CON FORO PASSACAVO IN ALLUMINIO ANODIZZATO PER ART.533 COD.ART.:L-0015

533

534

428

Profili in alluminio per STRISCE A LED



TAPPO CHIUSO IN ABS COLORE ARGENTO PER ART.526 COD.ART.: L-0001



TAPPO CON FORO PASSACAVO IN ABS COLORE ARGENTO PER ART.526 COD.ART.:L-0002



MOLLA PER FISSAGGIO A CARTONGESSO PER ART. FM526 COD.ART.: L-0017



TAPPO CHIUSO IN ABS COLORE ARGENTO PER ART.527 COD.ART.: L-0006



TAPPO CON FORO PASSACAVO IN ABS COLORE ARGENTO PER ART.527 COD.ART.: L-0007



STAFFA DI FISSAGGIO IN ABS COLORE ARGENTO ART.527 COD.ART.: L-0008



STAFFA DI FISSAGGIO ROTANTE REGOLABILE IN ABS COLORE ARGENTO ART.527 COD.ART.: L-0014



TAPPO CHIUSO IN ABS COLORE ARGENTO PER ART.528 COD.ART.:L-0010



TAPPO CON FORO PASSACAVO IN ABS COLORE ARGENTO PER ART.528 COD.ART.: L-0011



KIT STAFFA PER FISSAGGIO A PARETE/SOSPENSIONE COLORE NERO PER ART.528 COD.ART.: L-0013



PASSA CAVO COD.ART.: L-0012



VITI AUTOFILETTANTI 2,9X9,5 PER FISSAGGIO TAPPO AL PROFILO FM526 E FM528 CONFEZIONI DA 100PZ COD.ART.: L-0005 - VITI AUTOFILETTANTI 2x6 PER FISSAGGIO TAPPO AL PROFILO FM527 CONFEZIONI DA 100PZ COD.ART.: L-0009



TAPPO CHIUSO IN ALLUMINIO ANODIZZATO ARGENTO PER ART.533 COD.ART.:L-0015



TAPPO CON FORO PASSACAVO IN ALLUMINIO ANODIZZATO ARGENTO PER ART.528 COD.ART.: L-0016

Cataloghi Online: www.omar-alluminio.it

www.omar-alluminio.com

PROFILATI ALLUMINIO A DISEGNO / STANDARD / SPECIALI / E PER:

ELETTRONICA / LED / FOTOVOLTAICO / AUTOMAZIONE ROBOTICA / PNEUMATICA / AUTOMOTIVE

Via Newton, n.12

20016 Pero (Milano - Italy)

Tel. +39 02 3535955 r.a. Fax. +39 02 3539929

E-Mail: info@omar-alluminio.it



Via Newton, n.12
 20016 Pero (Milano - Italy)
 Tel. +39 02 3535955 r.a. Fax. +39 02 3539929
 E.Mail: info@omar-alluminio.it

Cataloghi Online: www.omar-alluminio.it
www.omar-alluminio.com

PROFILATI ALLUMINIO A DISEGNO / STANDARD / SPECIALI / E PER:
 ELETTRONICA / LED / FOTOVOLTAICO / AUTOMAZIONE ROBOTICA / PNEUMATICA / AUTOMOTIVE

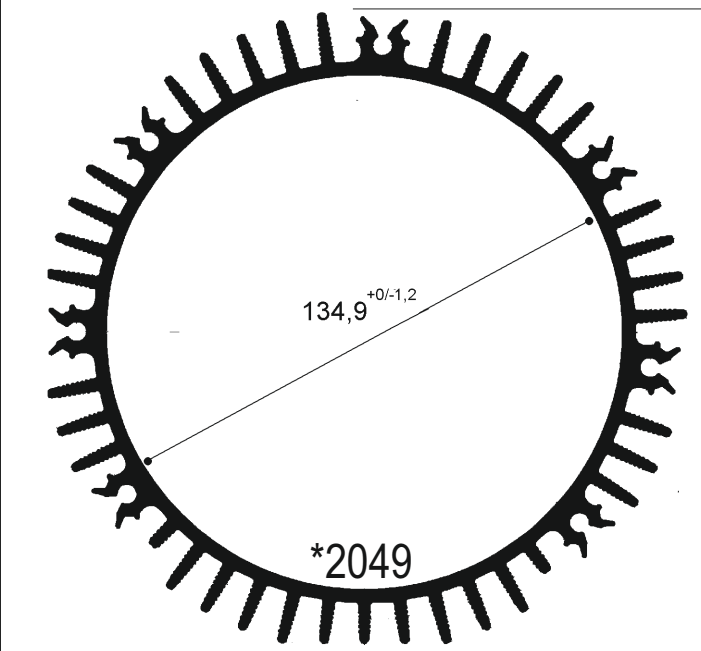
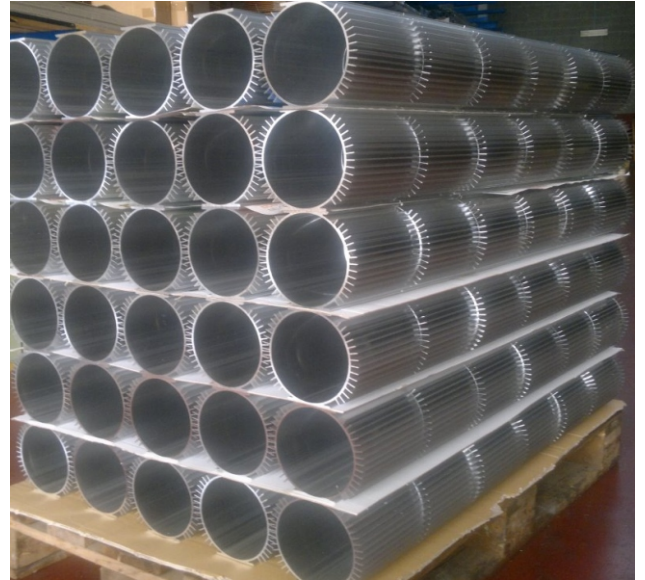
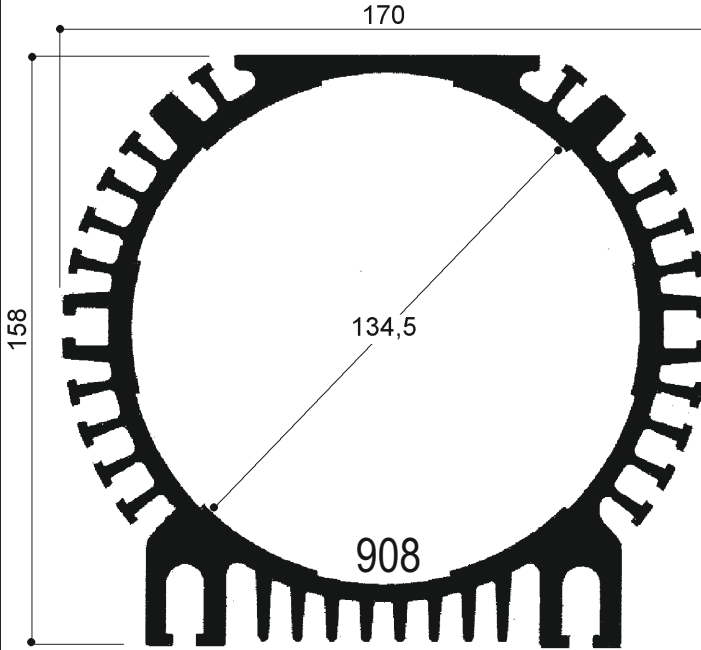
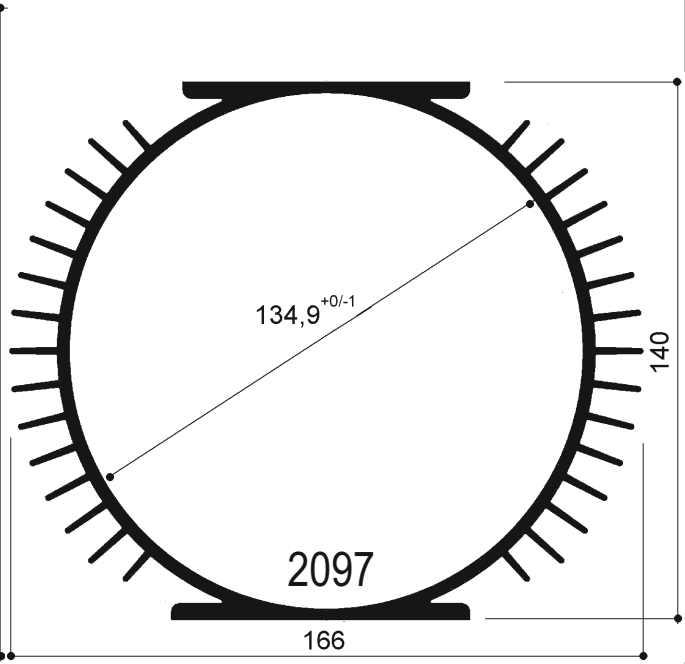
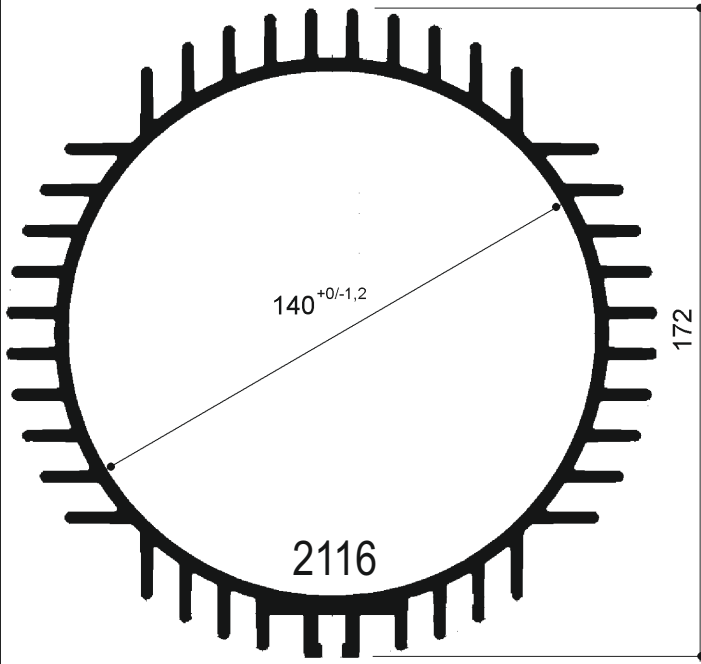

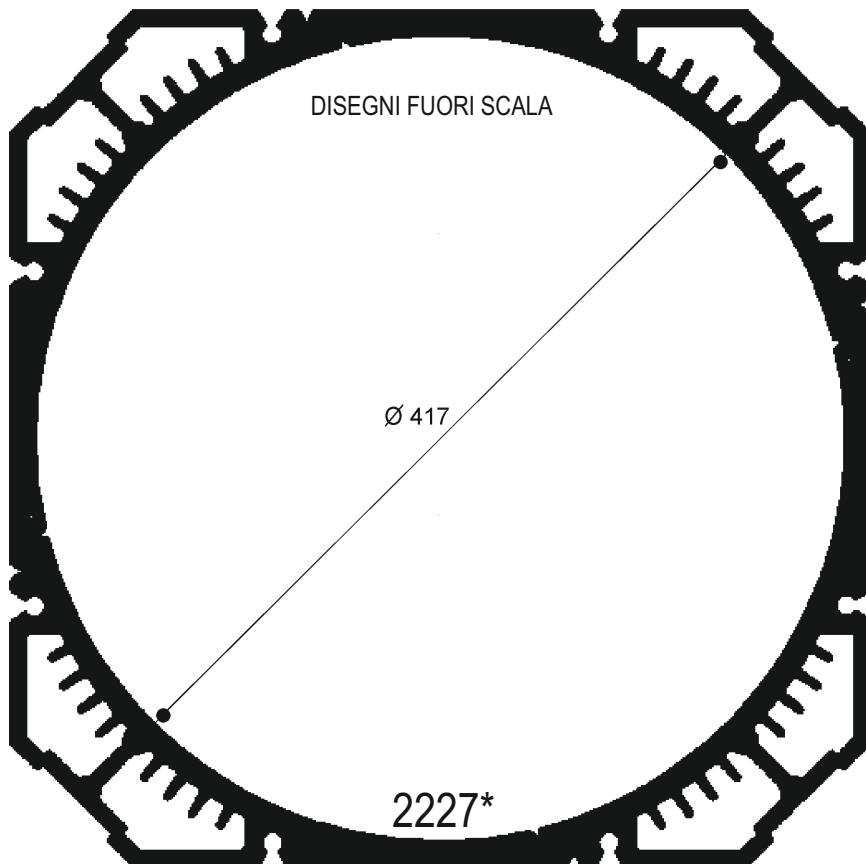
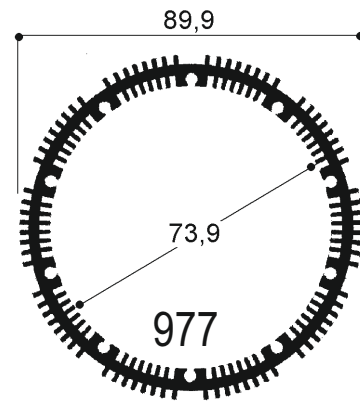
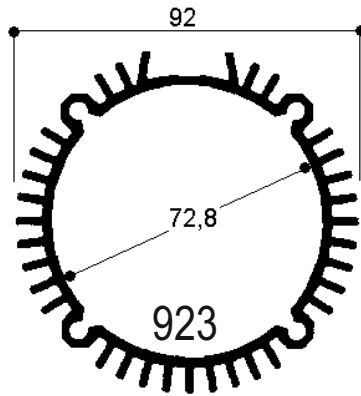
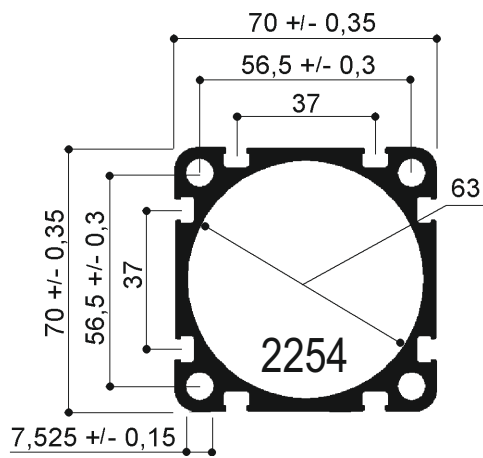
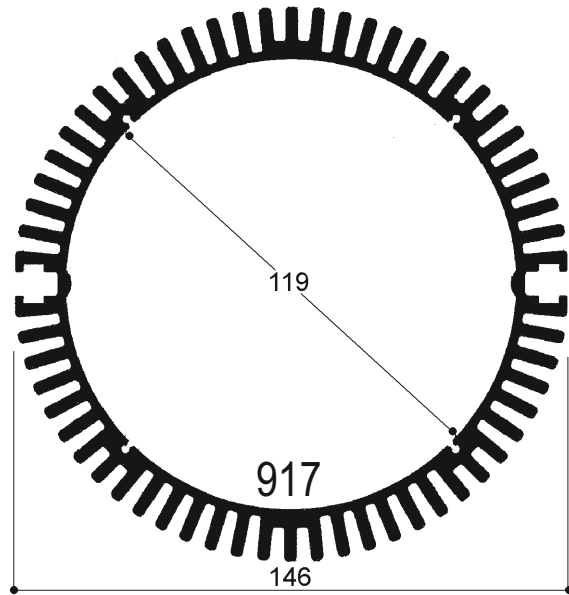
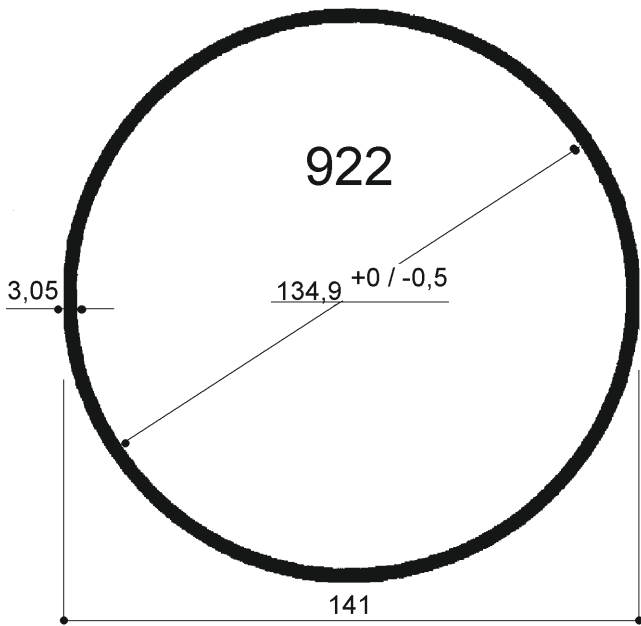

* PROFILO RISERVATO

Via Newton, n.12
 20016 Pero (Milano - Italy)
 Tel. +39 02 3535955 r.a. Fax. +39 02 3539929
 E-Mail: info@omar-alluminio.it

Cataloghi Online: www.omar-alluminio.it
www.omar-alluminio.com

PROFILATI ALLUMINIO A DISEGNO / STANDARD / SPECIALI / E PER:
 ELETTRONICA / LED / FOTOVOLTAICO / AUTOMAZIONE ROBOTICA / PNEUMATICA / AUTOMOTIVE



Via Newton, n. 12
 20016 Pero (Milano - Italy)
 Tel. +39 02 3535955 r.a. Fax. +39 02 3539929
 E. Mail: info@omar-alluminio.it

Cataloghi Online: www.omar-alluminio.it
 www.omar-alluminio.com
 PROFILATI ALLUMINIO A DISEGNO / STANDARD / SPECIALI / E PER:
 ELETTRONICA / LED / FOTOVOLTAICO / AUTOMAZIONE ROBOTICA / PNEUMATICA / AUTOMOTIVE



DISEGNI META' DEL VERO (1:2)- SCALE 1:2



FOTO DI ESEMPIO: PROFILO ESTRUSO IN ALLUMINIO PER LA DIFFUSIONE SONORA TAGLIATO A MISURA STOCCATO SU PALLET PER LA CONSEGNA



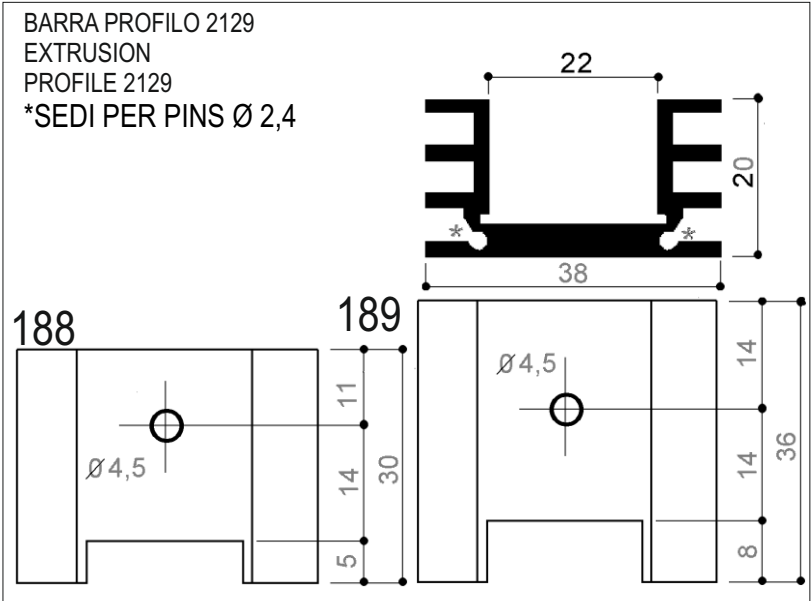
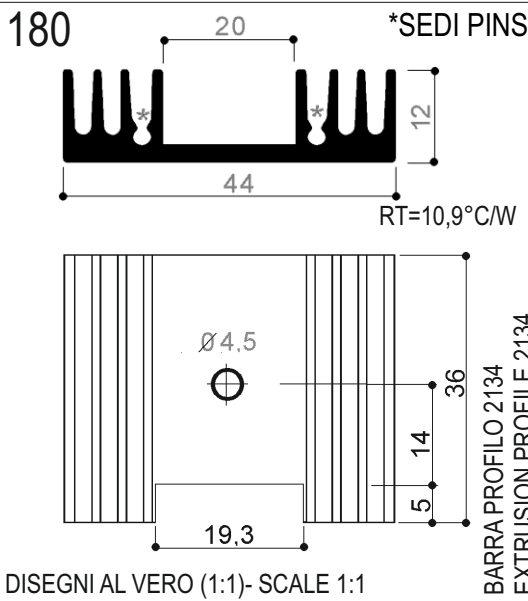
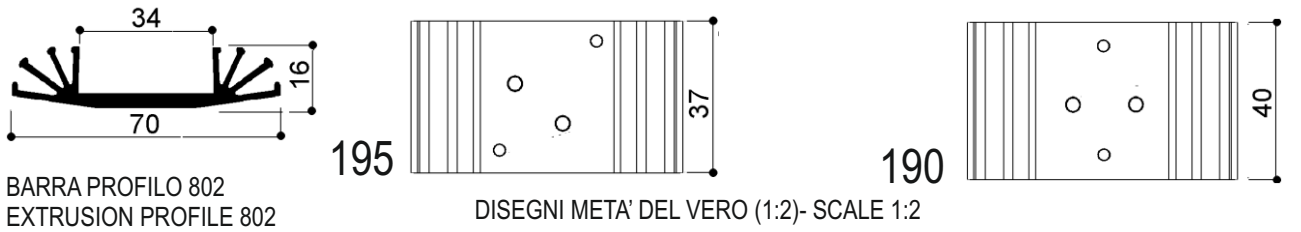
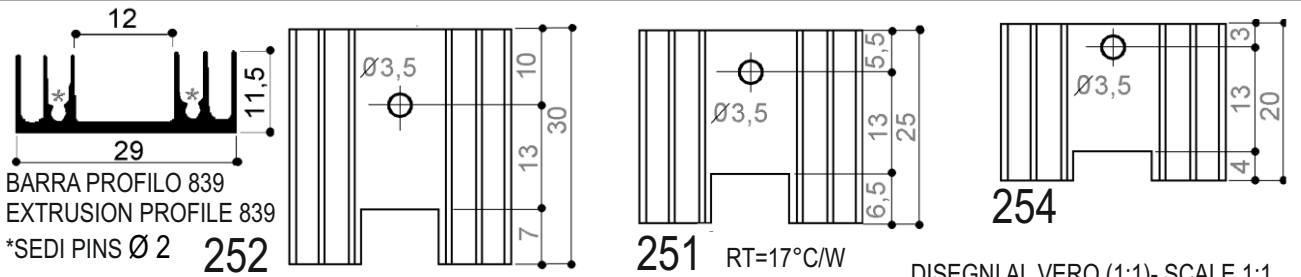
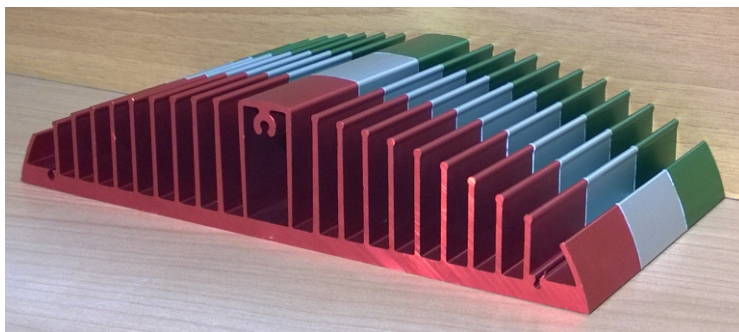
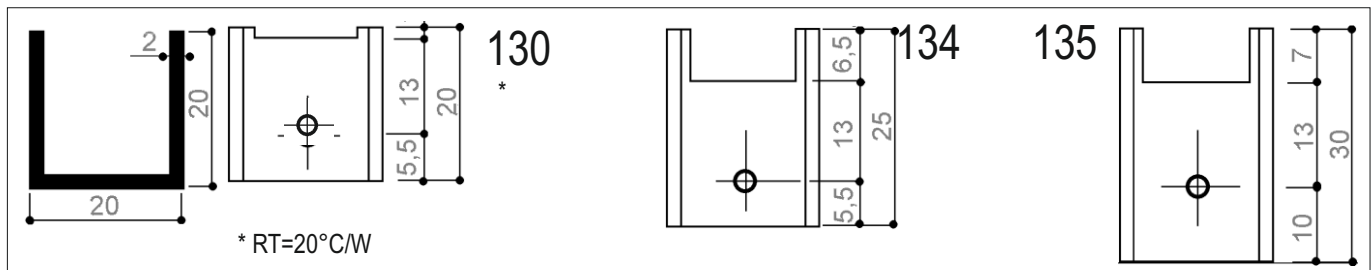
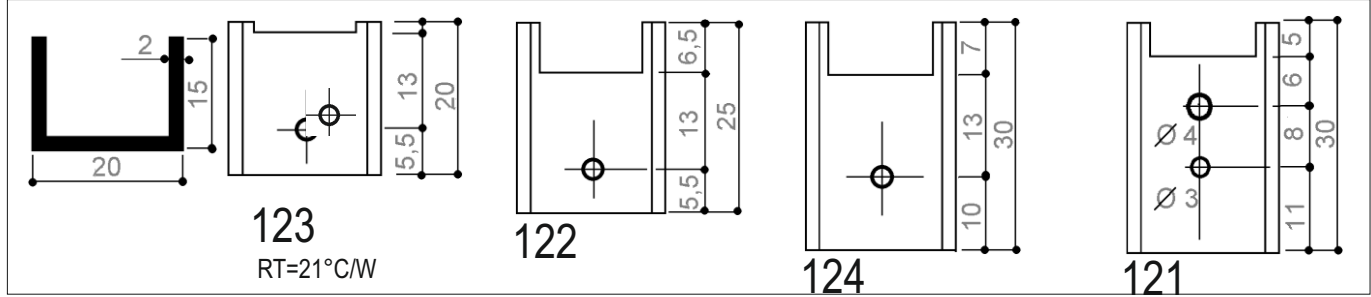
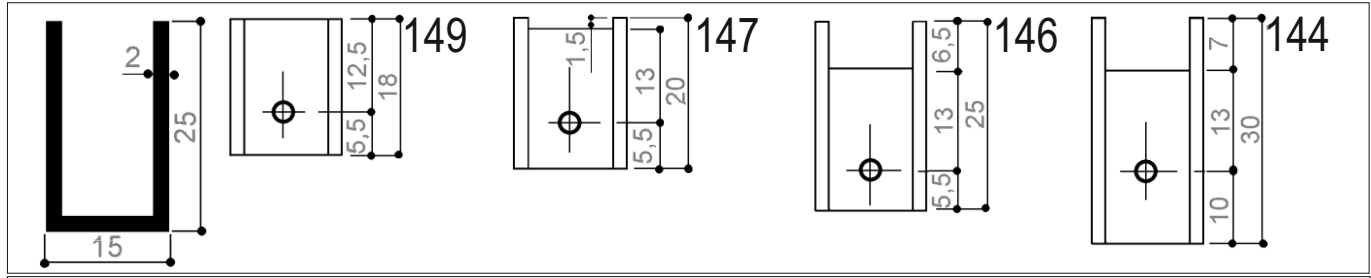
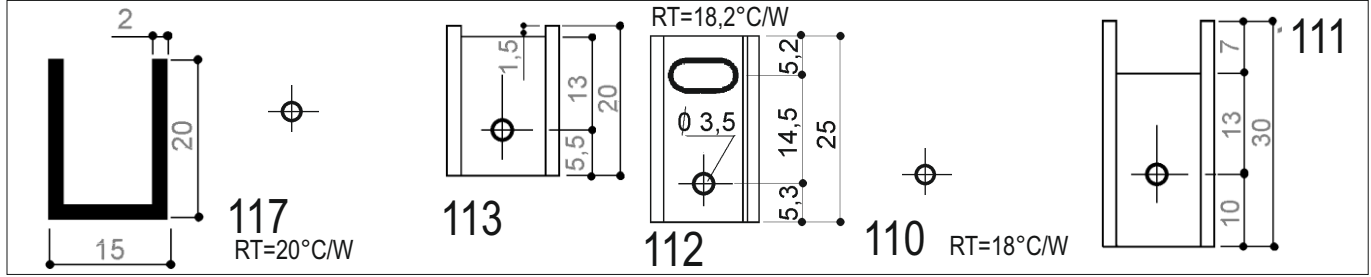
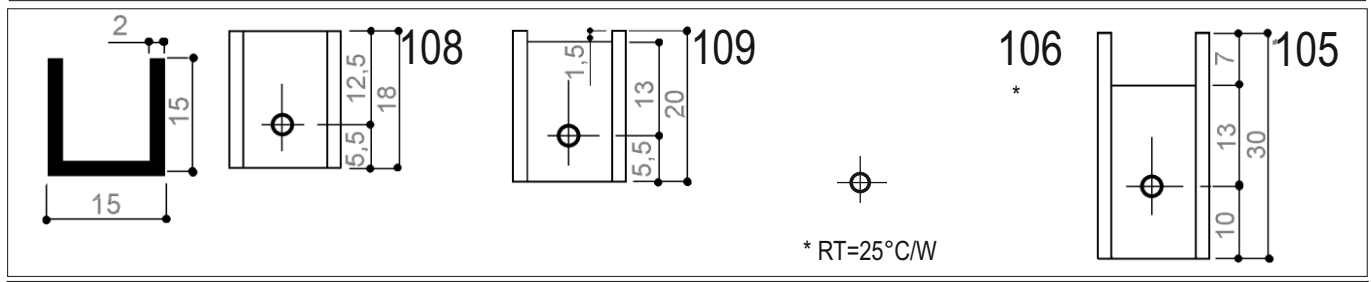
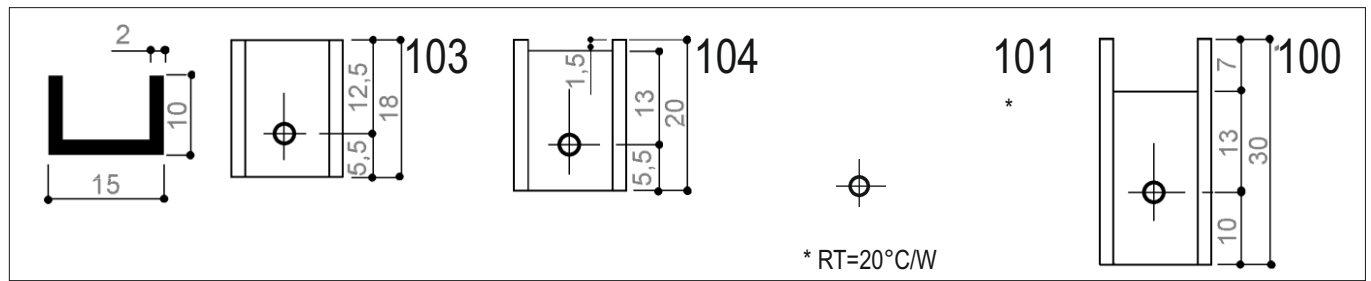

Via Newton, n.12
20016 Pero (Milano - Italy)
Tel. +39 02 3535955 r.a. Fax. +39 02 3539929
E-Mail: info@omar-alluminio.it

Cataloghi Online: www.omar-alluminio.it
www.omar-alluminio.com
PROFILATI ALLUMINIO A DISEGNO / STANDARD / SPECIALI / E PER:
ELETTRONICA / LED / FOTOVOLTAICO / AUTOMAZIONE ROBOTICA / PNEUMATICA / AUTOMOTIVE



Via Newton, n.12
20016 Pero (Milano - Italy)
Tel. +39 02 3535955 r.a. Fax. +39 02 3539929
E.Mai: info@omar-alluminio.it

Cataloghi Online: www.omar-alluminio.it
www.omar-alluminio.com

PROFILATI ALLUMINIO A DISEGNO / STANDARD / SPECIALI / E PER:
ELETTRONICA / LED / FOTOVOLTAICO / AUTOMAZIONE ROBOTICA / PNEUMATICA / AUTOMOTIVE

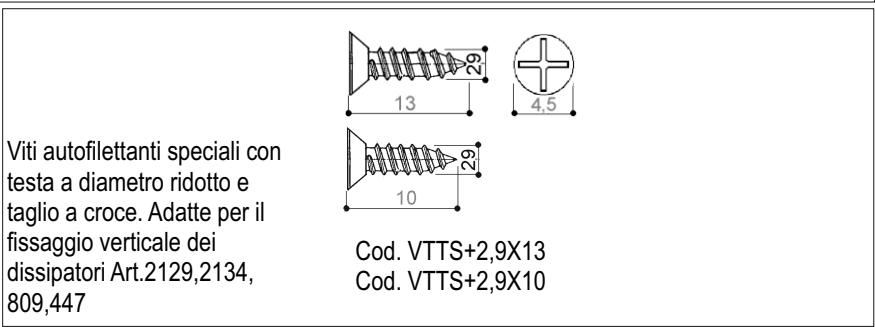
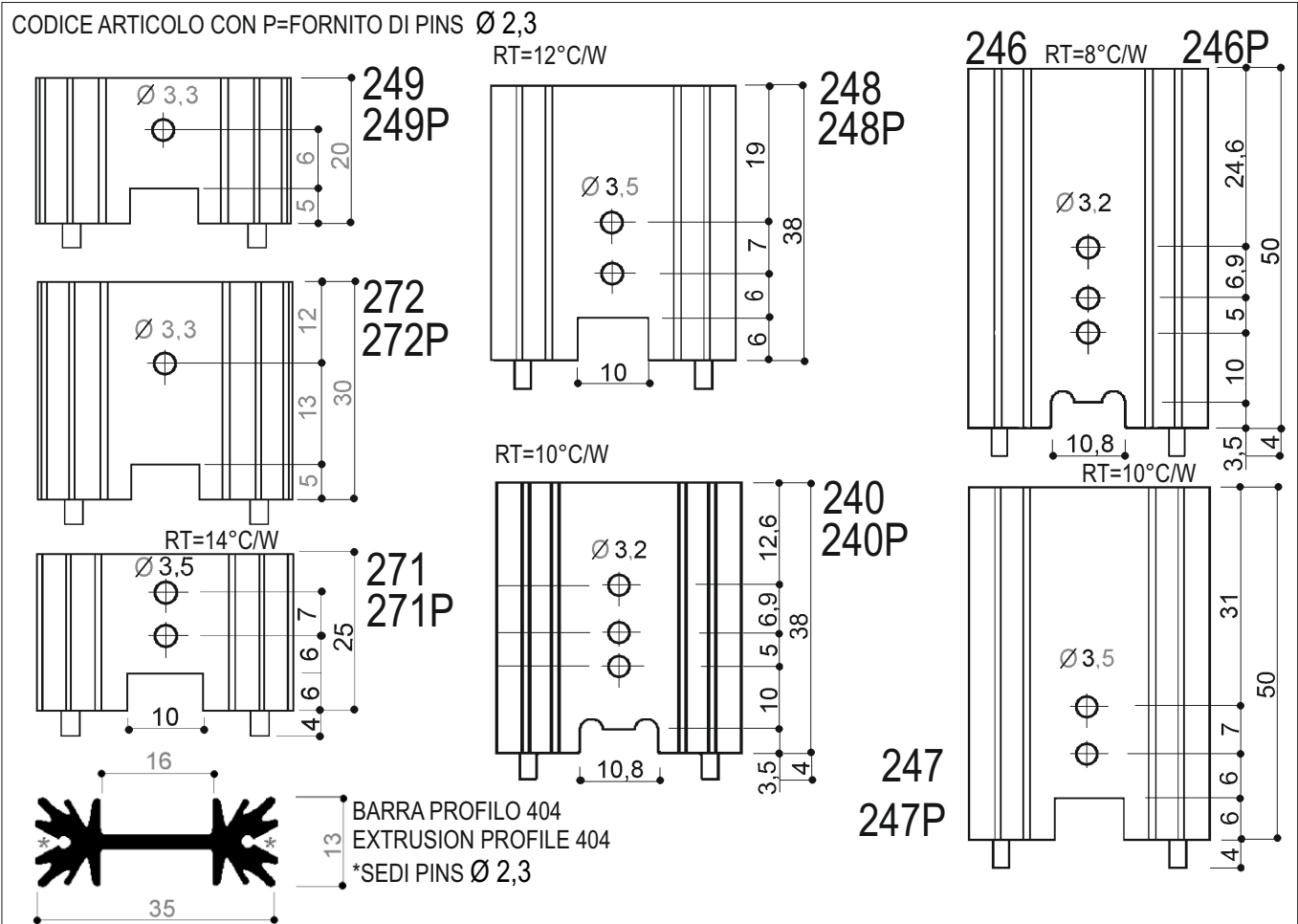
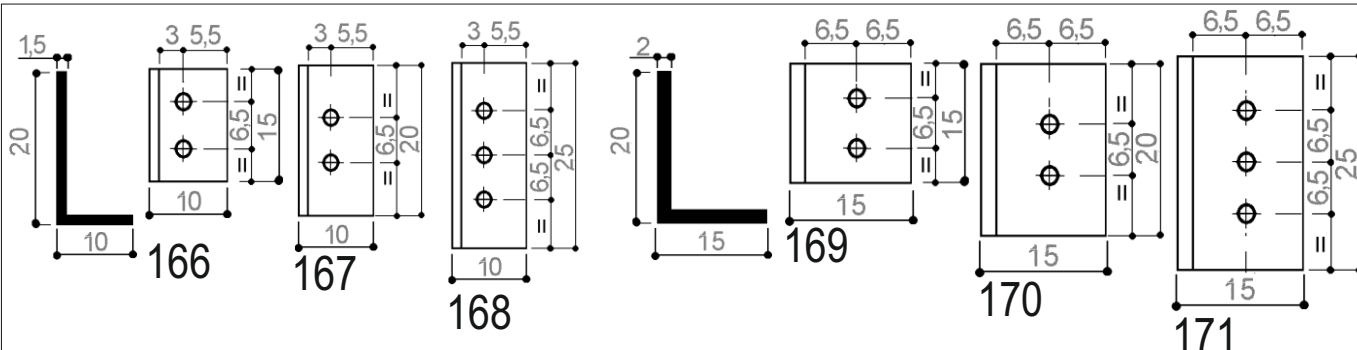
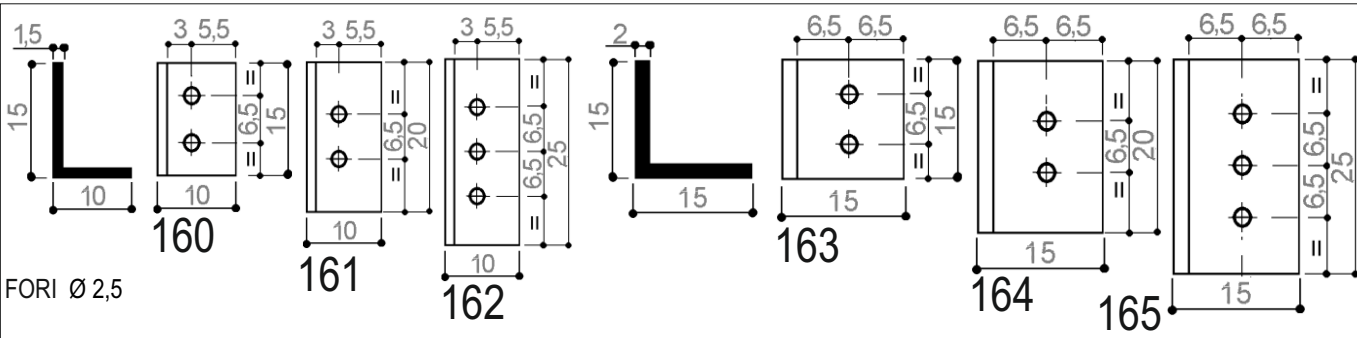

BARRA PROFILO 447 EXTRUSION PROFILE 447

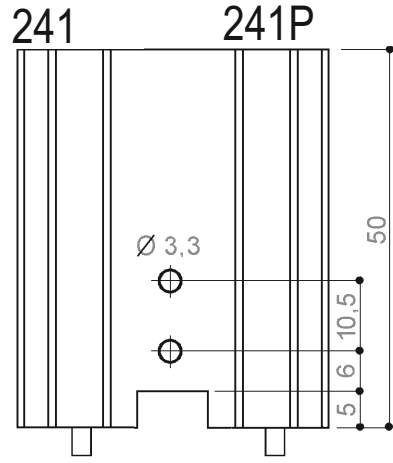
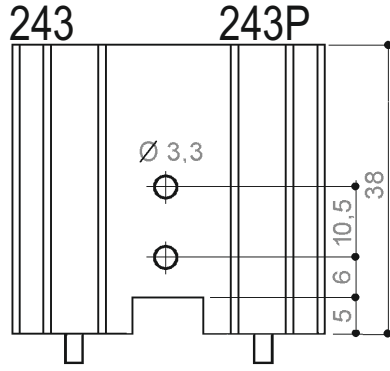
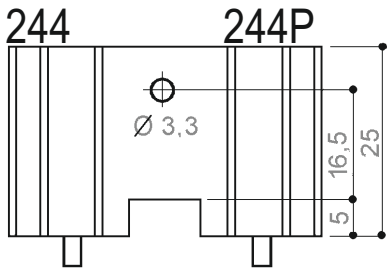

DISEGNI AL VERO (1:1) - SCALE 1:1

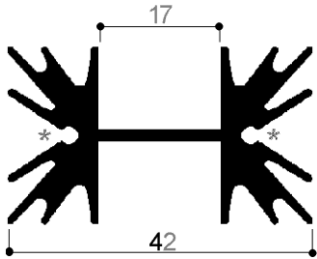
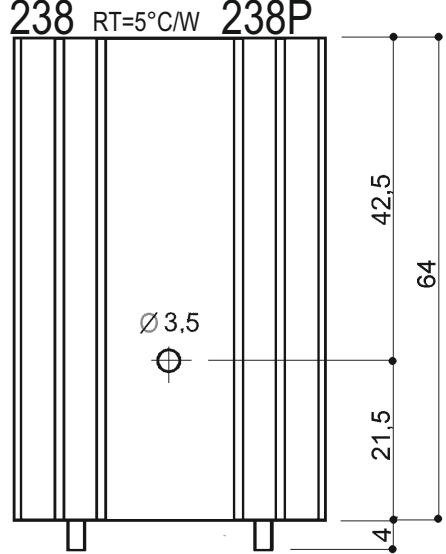
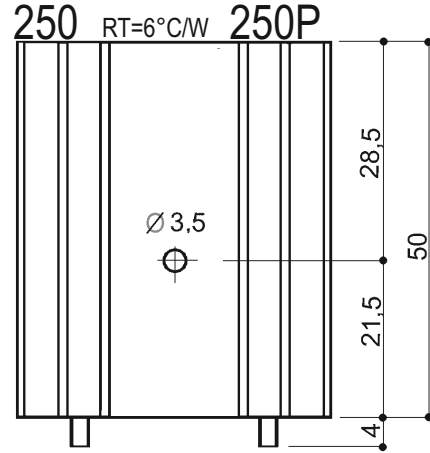
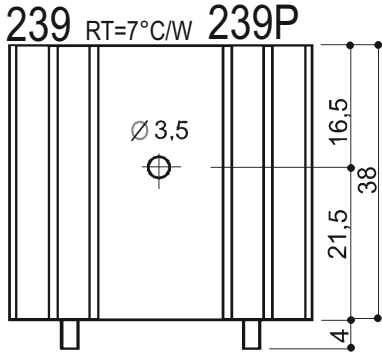

*SEDI PINS Ø 2,3
CODICE ARTICOLO
CON P=FORNITO DI PINS Ø 2,3

AGGIORNAMENTO CONTINUO - ED. DEL 02-2017 - RIPRODUZIONE VIETATA

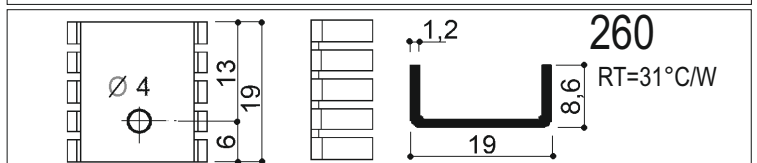
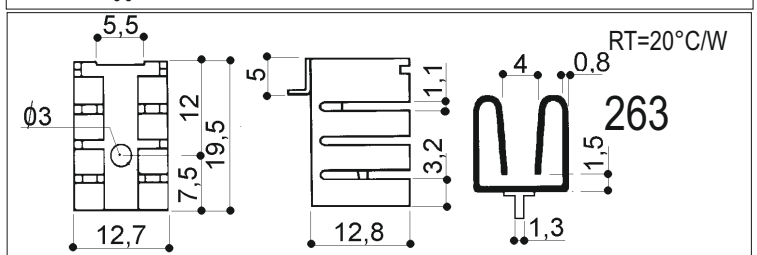
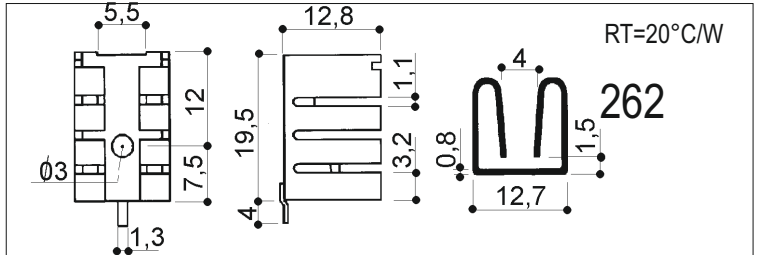
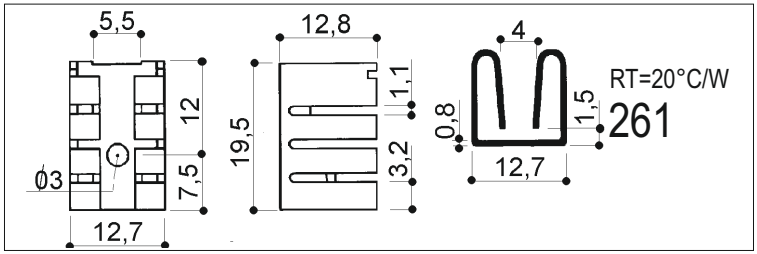
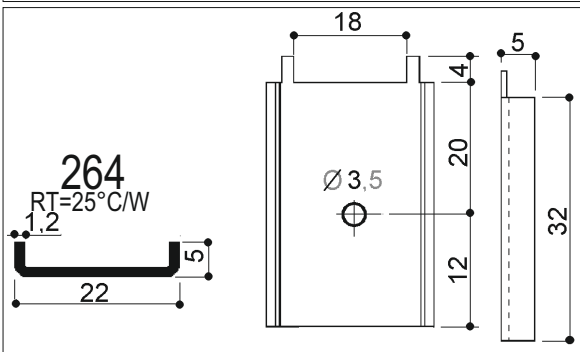
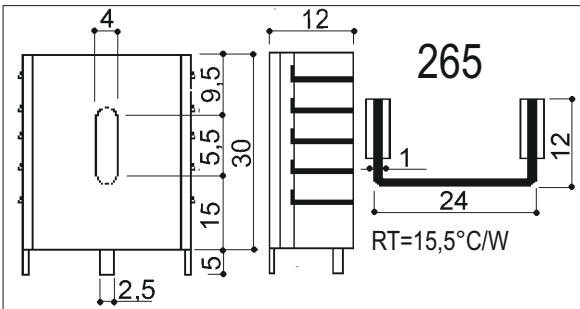

Cataloghi Online: www.omar-alluminio.it
www.omar-alluminio.com

PROFILATI ALLUMINIO A DISEGNO / STANDARD / SPECIALI / E PER:
ELETTRONICA / LED / FOTOVOLTAICO / AUTOMAZIONE ROBOTICA / PNEUMATICA / AUTOMOTIVE

Via Newton, n.12
20016 Pero (Milano - Italy)
Tel. +39 02 3535955 r.a. Fax. +39 02 3539929
E-Mail: info@omar-alluminio.it



Via Newton, n.12
20016 Pero (Milano - Italy)
Tel. +39 02 3535955 r.a. Fax. +39 02 3539929
E-Mail: info@omar-alluminio.it

Cataloghi Online: www.omar-alluminio.it
www.omar-alluminio.com
PROFILATI ALLUMINIO A DISEGNO / STANDARD / SPECIALI / E PER:
ELETTRONICA / LED / FOTOVOLTAICO / AUTOMAZIONE ROBOTICA / PNEUMATICA / AUTOMOTIVE



Indice Articoli

Consultate il Catalogo aggiornato Online
all'indirizzo www.omar-alluminio.it

COD.	TIPO ARTICOLO	PAG	COD.	TIPO ARTICOLO	PAG	COD.	TIPO ARTICOLO	PAG
100	DISSIPATORE	67	311	PROFILI SPECIALI	107	453	DISSIPATORE	31
101	DISSIPATORE	67	328	PROFILI COMPONIBILI	71	454	DISSIPATORE	33
103	DISSIPATORE	67	330	PROFILI COMPONIBILI	73	455	DISSIPATORE	36
104	DISSIPATORE	67	333	PROFILI FOTOVOLTAICO	76	456	DISSIPATORE	43
105	DISSIPATORE	67	334	PROFILI FOTOVOLTAICO	76	457	DISSIPATORE	46
106	DISSIPATORE	67	335	PROFILI FOTOVOLTAICO	76	458	DISSIPATORE	31
108	DISSIPATORE	67	345	PROFILI COMPONIBILI	75	459	DISSIPATORE	32
109	DISSIPATORE	67	357	PROFILI COMPONIBILI	72	460	DISSIPATORE	37
110	DISSIPATORE	67	358	PROFILI COMPONIBILI	72	461	DISSIPATORE	49
111	DISSIPATORE	67	359	PROFILI FOTOVOLTAICO	76	462	DISSIPATORE	34
112	DISSIPATORE	67	360	PROFILI COMPONIBILI	75	463	DISSIPATORE	33
113	DISSIPATORE	67	361	PROFILI COMPONIBILI	75	464	DISSIPATORE	34
117	DISSIPATORE	67	362	PROFILI COMPONIBILI	75	465	DISSIPATORE	37
121	DISSIPATORE	67	363	PROFILI COMPONIBILI	75	466	DISSIPATORE	44
122	DISSIPATORE	67	364	PROFILI COMPONIBILI	75	467	DISSIPATORE	47
123	DISSIPATORE	67	365	PROFILI COMPONIBILI	75	468	DISSIPATORE	52
124	DISSIPATORE	67	366	PROFILI COMPONIBILI	75	469	DISSIPATORE	53
130	DISSIPATORE	67	367	PROFILI COMPONIBILI	75	470	DISSIPATORE	47
134	DISSIPATORE	67	371	PROFILI COMPONIBILI	80	471	DISSIPATORE	45
135	DISSIPATORE	67	372	PROFILI COMPONIBILI	81	472	DISSIPATORE	48
144	DISSIPATORE	67	373	PROFILI COMPONIBILI	82	473	DISSIPATORE	49
146	DISSIPATORE	67	374	PROFILI COMPONIBILI	83	474	DISSIPATORE	48
147	DISSIPATORE	67	375	PROFILI COMPONIBILI	84	475	DISSIPATORE	36
149	DISSIPATORE	67	376	PROFILI COMPONIBILI	80	476	DISSIPATORE	35
160	DISSIPATORE	68	377	PROFILI COMPONIBILI	81	477	DISSIPATORE	32
161	DISSIPATORE	68	400	DISSIPATORE	6	478	DISSIPATORE	50
162	DISSIPATORE	68	401	DISSIPATORE	6	479	DISSIPATORE	43
163	DISSIPATORE	68	402	DISSIPATORE	6	480	DISSIPATORE	38
164	DISSIPATORE	68	403	DISSIPATORE	6	481	DISSIPATORE	41
165	DISSIPATORE	68	404	DISSIPATORE	6	482	DISSIPATORE	42
166	DISSIPATORE	68	405	DISSIPATORE	6	483	DISSIPATORE	40
167	DISSIPATORE	68	406	DISSIPATORE	6	484	DISSIPATORE	39
168	DISSIPATORE	68	408	DISSIPATORE	7	485	DISSIPATORE	45
169	DISSIPATORE	68	409	DISSIPATORE	7	486	DISSIPATORE	35
170	DISSIPATORE	68	410	DISSIPATORE	7	487	DISSIPATORE	39
171	DISSIPATORE	68	411	DISSIPATORE	7	488	DISSIPATORE	16
180	DISSIPATORE	66	412	DISSIPATORE	7	489	DISSIPATORE	40
188	DISSIPATORE	66	413	DISSIPATORE	6	490	DISSIPATORE	51
189	DISSIPATORE	66	414	DISSIPATORE	56	491	DISSIPATORE	44
190	DISSIPATORE	66	415	DISSIPATORE	7	492	DISSIPATORE	41
195	DISSIPATORE	66	416	DISSIPATORE	7	493	DISSIPATORE	42
238	DISSIPATORE	69	417	DISSIPATORE	7	494	DISSIPATORE	46
239	DISSIPATORE	69	418	DISSIPATORE	7	495	DISSIPATORE	50
240	DISSIPATORE	68	419	DISSIPATORE	6	496	DISSIPATORE	51
241	DISSIPATORE	69	420	DISSIPATORE	56	497	DISSIPATORE	52
243	DISSIPATORE	69	421	DISSIPATORE	7	500	DISSIPATORE	8
244	DISSIPATORE	69	423	DISSIPATORE	6	503	DISSIPATORE	9
246	DISSIPATORE	68	424	DISSIPATORE	56	505	DISSIPATORE	10
247	DISSIPATORE	68	427	DISSIPATORE	56	509	DISSIPATORE	11
248	DISSIPATORE	68	428	DISSIPATORE	62	513	DISSIPATORE	12
249	DISSIPATORE	68	429	DISSIPATORE	13	517	DISSIPATORE	16
250	DISSIPATORE	69	430	DISSIPATORE	14	525	DISSIPATORE	15
251	DISSIPATORE	66	432	DISSIPATORE	13	526	DISSIPATORE	62
252	DISSIPATORE	66	433	DISSIPATORE	15	527	DISSIPATORE	62
254	DISSIPATORE	66	434	DISSIPATORE	24	528	DISSIPATORE	62
260	DISSIPATORE	69	437	DISSIPATORE	9	529	DISSIPATORE	11
261	DISSIPATORE	69	438	DISSIPATORE	11	530	DISSIPATORE	14
262	DISSIPATORE	69	439	DISSIPATORE	12	531	DISSIPATORE	9
263	DISSIPATORE	69	440	DISSIPATORE	13	532	DISSIPATORE	12
264	DISSIPATORE	69	441	DISSIPATORE	9	533	DISSIPATORE	62
265	DISSIPATORE	69	442	DISSIPATORE	7	534	DISSIPATORE	62
271	DISSIPATORE	68	443	DISSIPATORE	12	537	DISSIPATORE	9
272	DISSIPATORE	68	444	DISSIPATORE	11	600	DISSIPATORE	55
300	PROFILI SPECIALI	122	445	DISSIPATORE	21	601	DISSIPATORE	55
301	PROFILI SPECIALI	122	446	DISSIPATORE	7	602	DISSIPATORE	55
302	PROFILI SPECIALI	122	447	DISSIPATORE	6	603	DISSIPATORE	54
303	PROFILI SPECIALI	122	449	DISSIPATORE	7	604	DISSIPATORE	55
304	PROFILI COMPONIBILI	72	450	DISSIPATORE	31	605	DISSIPATORE	55
306	PROFILI COMPONIBILI	71	451	DISSIPATORE	32	606	DISSIPATORE	54
307	PROFILI COMPONIBILI	71	452	DISSIPATORE	33	608	DISSIPATORE	54

610	DISSIPATORE	54	762	PROFILI COMPONIBILI	78	849	DISSIPATORE	12
611	DISSIPATORE	54	763	PROFILI COMPONIBILI	78	850	DISSIPATORE	15
613	DISSIPATORE	54	764	PROFILI COMPONIBILI	78	851	DISSIPATORE	12
617	DISSIPATORE	9	765	PROFILI COMPONIBILI	78	852	DISSIPATORE	17
618	DISSIPATORE	9	766	PROFILI COMPONIBILI	78	853	DISSIPATORE	18
619	DISSIPATORE	54	768	PROFILI COMPONIBILI	78	855	DISSIPATORE	22
620	DISSIPATORE	53	769	PROFILI COMPONIBILI	71	856	DISSIPATORE	10
621	DISSIPATORE	54	770	PROFILI COMPONIBILI	71	857	DISSIPATORE	10
622	DISSIPATORE	22	771	PROFILI COMPONIBILI	71	858	DISSIPATORE	10
624	DISSIPATORE	17	772	PROFILI FOTOVOLTAICO	78	863	DISSIPATORE	10
626	DISSIPATORE	54	773	PROFILI FOTOVOLTAICO	78	864	DISSIPATORE	7
629	DISSIPATORE	12	774	PROFILI COMPONIBILI	78	865	DISSIPATORE	24
633	DISSIPATORE	53	775	PROFILI COMPONIBILI	74	867	DISSIPATORE	10
634	DISSIPATORE	20	776	PROFILI COMPONIBILI	72	868	DISSIPATORE	8
637	DISSIPATORE	54	777	PROFILI COMPONIBILI	72	869	DISSIPATORE	10
638	DISSIPATORE	55	778	PROFILI COMPONIBILI	74	871	DISSIPATORE	27
639	DISSIPATORE	55	779	PROFILI COMPONIBILI	74	872	DISSIPATORE	21
640	DISSIPATORE	56	780	PROFILI COMPONIBILI	74	873	DISSIPATORE	22
641	DISSIPATORE	56	784	PROFILI COMPONIBILI	71	874	DISSIPATORE	24
642	DISSIPATORE	55	785	PROFILI COMPONIBILI	71	875	DISSIPATORE	23
649	DISSIPATORE	8	786	PROFILI COMPONIBILI	74	876	DISSIPATORE	25
650	DISSIPATORE	8	787	PROFILI FOTOVOLTAICO	76	877	DISSIPATORE	22
651	DISSIPATORE	6	789	PROFILI COMPONIBILI	71	879	DISSIPATORE	19
652	DISSIPATORE	23	791	PROFILI FOTOVOLTAICO	76	880	DISSIPATORE	19
653	DISSIPATORE	12	797	PROFILI FOTOVOLTAICO	76	881	DISSIPATORE	18
708	PROFILI COMPONIBILI	74	801	DISSIPATORE	6	882	DISSIPATORE	9
709	PROFILI COMPONIBILI	74	802	DISSIPATORE	6	883	DISSIPATORE	8
710	PROFILI COMPONIBILI	74	803	DISSIPATORE	14	884	DISSIPATORE	8
711	PROFILI COMPONIBILI	74	804	DISSIPATORE	17	885	DISSIPATORE	14
715	PROFILI COMPONIBILI	79	805	DISSIPATORE	14	886	DISSIPATORE	12
716	PROFILI COMPONIBILI	79	806	DISSIPATORE	6	887	DISSIPATORE	15
717	PROFILI COMPONIBILI	79	807	DISSIPATORE	6	888	DISSIPATORE	8
718	PROFILI COMPONIBILI	79	808	DISSIPATORE	8	889	DISSIPATORE	13
719	PROFILI COMPONIBILI	79	809	DISSIPATORE	8	890	DISSIPATORE	11
720	PROFILI COMPONIBILI	79	810	DISSIPATORE	8	891	DISSIPATORE	15
721	PROFILI COMPONIBILI	79	811	DISSIPATORE	8	892	DISSIPATORE	9
722	PROFILI COMPONIBILI	79	812	DISSIPATORE	8	893	DISSIPATORE	8
723	PROFILI COMPONIBILI	79	813	DISSIPATORE	10	894	DISSIPATORE	22
724	PROFILI COMPONIBILI	79	814	DISSIPATORE	14	895	DISSIPATORE	13
725	PROFILI COMPONIBILI	79	815	DISSIPATORE	9	896	DISSIPATORE	17
726	PROFILI COMPONIBILI	73	816	DISSIPATORE	10	897	DISSIPATORE	22
727	PROFILI COMPONIBILI	73	817	DISSIPATORE	10	898	DISSIPATORE	16
729	PROFILI COMPONIBILI	73	818	DISSIPATORE	11	899	DISSIPATORE	24
730	PROFILI COMPONIBILI	72	819	DISSIPATORE	11	900	DISSIPATORE	13
731	PROFILI COMPONIBILI	72	820	DISSIPATORE	11	901	DISSIPATORE	17
732	PROFILI COMPONIBILI	72	821	DISSIPATORE	27	902	DISSIPATORE	23
733	PROFILI COMPONIBILI	72	822	DISSIPATORE	17	903	DISSIPATORE	13
734	PROFILI COMPONIBILI	72	823	DISSIPATORE	11	904	DISSIPATORE	14
735	PROFILI COMPONIBILI	71	824	DISSIPATORE	17	905	DISSIPATORE	14
736	PROFILI COMPONIBILI	71	825	DISSIPATORE	12	906	DISSIPATORE	10
737	PROFILI COMPONIBILI	71	826	DISSIPATORE	16	907	DISSIPATORE	11
739	PROFILI COMPONIBILI	72	827	DISSIPATORE	13	908	DISSIPATORE	64
740	PROFILI COMPONIBILI	72	828	DISSIPATORE	13	909	DISSIPATORE	8
741	PROFILI COMPONIBILI	73	829	DISSIPATORE	14	910	DISSIPATORE	27
742	PROFILI COMPONIBILI	73	830	DISSIPATORE	14	911	DISSIPATORE	19
743	PROFILI COMPONIBILI	73	831	DISSIPATORE	10	912	DISSIPATORE	16
745	PROFILI COMPONIBILI	72	832	DISSIPATORE	10	913	DISSIPATORE	55
747	PROFILI COMPONIBILI	72	833	DISSIPATORE	8	914	DISSIPATORE	9
748	PROFILI COMPONIBILI	74	834	DISSIPATORE	8	915	DISSIPATORE	8
749	PROFILI COMPONIBILI	74	835	DISSIPATORE	18	916	DISSIPATORE	10
750	PROFILI COMPONIBILI	72	836	DISSIPATORE	24	917	DISSIPATORE	65
751	PROFILI COMPONIBILI	74	837	DISSIPATORE	8	918	DISSIPATORE	27
752	PROFILI COMPONIBILI	74	838	DISSIPATORE	15	919	DISSIPATORE	8
753	PROFILI COMPONIBILI	73	839	DISSIPATORE	8	920	DISSIPATORE	22
754	PROFILI COMPONIBILI	72	841	DISSIPATORE	6	921	DISSIPATORE	11
755	PROFILI COMPONIBILI	71	842	DISSIPATORE	10	922	DISSIPATORE	65
756	PROFILI COMPONIBILI	71	844	DISSIPATORE	13	923	DISSIPATORE	65
757	PROFILI COMPONIBILI	71	845	DISSIPATORE	11	924	DISSIPATORE	18
759	PROFILI COMPONIBILI	72	846	DISSIPATORE	16	925	DISSIPATORE	20
760	PROFILI COMPONIBILI	71	847	DISSIPATORE	11	926	DISSIPATORE	25
761	PROFILI COMPONIBILI	78	848	DISSIPATORE	14	927	DISSIPATORE	25

Cataloghi Online: www.omar-alluminio.it

www.omar-alluminio.com

PROFILATI ALLUMINIO A DISEGNO / STANDARD / SPECIALI / E PER:

ELETTRONICA / LED / FOTOVOLTAICO / AUTOMAZIONE ROBOTICA / PNEUMATICA / AUTOMOTIVE

Via Newton, n. 12

20016 Pero (Milano - Italy)

Tel. +39 02 3535955 r.a. Fax. +39 02 3539929

E-Mail: info@omar-alluminio.it



Via Newton, n.12
20016 Pero (Milano - Italy)
Tel. +39 02 3535955 r.a. Fax. +39 02 3539929
E-Mail: info@omar-alluminio.it

Cataloghi Online: www.omar-alluminio.it
www.omar-alluminio.com
PROFILATI ALLUMINIO A DISEGNO / STANDARD / SPECIALI / E PER:
ELETTRONICA / LED / FOTOVOLTAICO / AUTOMAZIONE ROBOTICA / PNEUMATICA / AUTOMOTIVE



Indice Articoli

Consultate il Catalogo aggiornato Online
all'indirizzo www.omar-alluminio.it

928	DISSIPATORE	18	1102	PROFILI SPECIALI	119	2036	DISSIPATORE	8
929	DISSIPATORE	20	1103	PROFILI SPECIALI	119	2040	PROFILI SPECIALI	107
930	DISSIPATORE	26	1104	PROFILI SPECIALI	119	2041	PROFILI COMPONIBILI	78
931	DISSIPATORE	12	1106	PROFILI SPECIALI	119	2042	PROFILI COMPONIBILI	78
932	DISSIPATORE	19	1107	PROFILI SPECIALI	119	2043	PROFILI COMPONIBILI	78
933	DISSIPATORE	23	1200	PROFILI SPECIALI	118	2044	PROFILI RACLE	115
934	DISSIPATORE	8	1201	PROFILI SPECIALI	118	2047	DISSIPATORE	3
936	DISSIPATORE	14	1202	PROFILI SPECIALI	118	2048	DISSIPATORE	102
937	DISSIPATORE	18	1203	PROFILI SPECIALI	118	2049	DISSIPATORE	64
938	DISSIPATORE	10	1204	PROFILI SPECIALI	118	2052	CONTENITORE ELETTRONICA	3
939	DISSIPATORE	10	1205	PROFILI SPECIALI	118	2058	PROFILI SPECIALI	122
940	DISSIPATORE	16	1206	PROFILI SPECIALI	118	2061	DISSIPATORE	3
941	DISSIPATORE	11	1207	PROFILI SPECIALI	118	2065	CONTENITORE ELETTRONICA	3
944	DISSIPATORE	9	1208	PROFILI SPECIALI	118	2072	DISSIPATORE	9
945	DISSIPATORE	8	1209	PROFILI SPECIALI	118	2072D46	DISSIPATORE	9
946	DISSIPATORE	25	1210	PROFILI SPECIALI	118	2073	DISSIPATORE	11
947	DISSIPATORE	21	1211	PROFILI SPECIALI	118	2073D70	DISSIPATORE	10
948	DISSIPATORE	20	1212	PROFILI SPECIALI	118	2074	DISSIPATORE	9
950	DISSIPATORE	21	1213	PROFILI SPECIALI	118	2074D46	DISSIPATORE	9
951	DISSIPATORE	10	1214	PROFILI SPECIALI	118	2075	DISSIPATORE	9
952	DISSIPATORE	24	1300	PROFILI SPECIALI	102	2076	DISSIPATORE	12
953	PROFILI SPECIALI	105	1302	PROFILI SPECIALI	102	2091	CONTENITORE ELETTRONICA	3
956	DISSIPATORE	18	1303	PROFILI SPECIALI	102	2096	PROFILI SPECIALI	122
958	DISSIPATORE	23	1305	PROFILI SPECIALI	102	2097	DISSIPATORE	64
959	DISSIPATORE	14	1306	PROFILI SPECIALI	102	2098	DISSIPATORE	60
960	DISSIPATORE	20	1308	PROFILI SPECIALI	102	2099	DISSIPATORE	6
961	DISSIPATORE	31	1309	PROFILI SPECIALI	102	2100	DISSIPATORE	8
962	DISSIPATORE	26	1312	PROFILI SPECIALI	102	2101	DISSIPATORE	68
963	DISSIPATORE	9	1313	PROFILI SPECIALI	102	2106	PROFILI RACLE	115
965	DISSIPATORE	6	1315	PROFILI SPECIALI	102	2108	DISSIPATORE	23
967	DISSIPATORE	15	1321	PROFILI SPECIALI	102	2111	PROFILI SPECIALI	122
968	DISSIPATORE	14	1322	PROFILI SPECIALI	102	2112	DISSIPATORE	10
969	DISSIPATORE	56	1323	PROFILI SPECIALI	102	2113	PROFILI RACLE	115
970	DISSIPATORE	12	1324	PROFILI SPECIALI	102	2115	DISSIPATORE	13
971	DISSIPATORE	13	1325	PROFILI SPECIALI	102	2116	DISSIPATORE	64
972	DISSIPATORE	6	1326	PROFILI SPECIALI	102	2119	DISSIPATORE	8
973	DISSIPATORE	21	1328	PROFILI SPECIALI	102	2120	PROFILI SPECIALI	116
974	DISSIPATORE	18	1329	PROFILI SPECIALI	102	2125	DISSIPATORE	11
975	DISSIPATORE	6	1330	PROFILI SPECIALI	102	2126	CONTENITORE ELETTRONICA	3
976	DISSIPATORE	21	1331	PROFILI SPECIALI	102	2127	PROFILI SPECIALI	122
977	DISSIPATORE	65	1333	PROFILI SPECIALI	102	2129	DISSIPATORE	8
978	DISSIPATORE	11	1338	PROFILI SPECIALI	102	2131	CONTENITORE ELETTRONICA	5
979	DISSIPATORE	26	1400	PROFILI RACLE	115	2134	DISSIPATORE	9
980	DISSIPATORE	28	1403	PROFILI RACLE	115	2136	PROFILI SPECIALI	104
981	DISSIPATORE	28	1404	PROFILI RACLE	115	2139	DISSIPATORE	8
982	DISSIPATORE	29	1405	PROFILI RACLE	115	2141	DISSIPATORE	27
983/N	DISSIPATORE	13	1407	PROFILI RACLE	115	2142	DISSIPATORE	8
984	DISSIPATORE	19	1408	PROFILI RACLE	115	2148	DISSIPATORE	13
985	DISSIPATORE	14	1409	PROFILI RACLE	115	2153	DISSIPATORE	13
986	DISSIPATORE	29	1412	PROFILI RACLE	115	2154	CONTENITORE ELETTRONICA	3
987	DISSIPATORE	29	1413	PROFILI RACLE	115	2155	DISSIPATORE	26
988	DISSIPATORE	30	1417	PROFILI RACLE	115	2156	CONTENITORE ELETTRONICA	3
989	DISSIPATORE	30	1418	PROFILI RACLE	116	2158	DISSIPATORE	9
990	DISSIPATORE	30	1419	PROFILI RACLE	116	2161	PROFILI SPECIALI	109
991	DISSIPATORE	30	1420	PROFILI RACLE	115	2163	PROFILI RACLE	116
992	DISSIPATORE	28	1421	PROFILI RACLE	116	2170	DISSIPATORE	14
993	DISSIPATORE	29	1422	PROFILI RACLE	116	2176	DISSIPATORE	10
994	DISSIPATORE	24	1423	PROFILI RACLE	116	2181	DISSIPATORE	9
996	DISSIPATORE	24	1424	PROFILI SPECIALI	115	2182	DISSIPATORE	20
997	DISSIPATORE	11	1425	PROFILI SPECIALI	116	2183	PROFILI SPECIALI	113
998	DISSIPATORE	17	2005	CONTENITORE ELETTRONICA	5	2187	CONTENITORE ELETTRONICA	3
999	DISSIPATORE	14	2012	PROFILI SPECIALI	121	2189	CONTENITORE ELETTRONICA	1
1000	PROFILI STAND	70	2014	DISSIPATORE	56	2193	DISSIPATORE	12
1001	PROFILI STAND	70	2015	PROFILI RACLE	115	2196	DISSIPATORE	6
1002	PROFILI STAND	70	2017	DISSIPATORE	58	2197	DISSIPATORE	11
1005	PROFILI STAND	70	2019	PROFILI SPECIALI	114	2198	DISSIPATORE	7
1008	PROFILI STAND	70	2021	PROFILI SPECIALI	105	2199	DISSIPATORE	7
1009	PROFILI STAND	70	2022	PROFILI SPECIALI	105	2200	PROFILI PNEUMATICI	98
1013	PROFILI STAND	70	2024	PROFILI SPECIALI	105	2202	DISSIPATORE	8
1100	PROFILI SPECIALI	119	2028	CONTENITORE ELETTRONICA	3	2203	DISSIPATORE	55
1101	PROFILI SPECIALI	119	2031	PROFILI RACLE	115	2210	DISSIPATORE	55

Indice Articoli

Consultate il Catalogo aggiornato Online
all'indirizzo www.omar-alluminio.it

2216	DISSIPATORE	8	3002	PROFILI SPECIALI	104	3086	PROFILI SPECIALI	120
2219	DISSIPATORE	6	3003	PROFILI SPECIALI	112	3087	PROFILI SPECIALI	120
2220	PROFILI SPECIALI	122	3004	PROFILI SPECIALI	112	3088	PROFILI SPECIALI	120
2221	PROFILI SPECIALI	105	3004-1	PROFILI SPECIALI	112	3089	PROFILI SPECIALI	120
2222	PROFILI SPECIALI	105	3006	PROFILI SPECIALI	114	3090	PROFILI SPECIALI	120
2226	PROFILI SPECIALI	115	3007	PROFILI SPECIALI	114	3091	PROFILI SPECIALI	120
2227	DISSIPATORE	65	3008	PROFILI SPECIALI	114	3092	PROFILI SPECIALI	120
2228	DISSIPATORE	105	3010	PROFILI SPECIALI	108	3093	PROFILI SPECIALI	120
2229	PROFILI SPECIALI	108	3011	PROFILI SPECIALI	108	3097	DISSIPATORE	8
2230	PROFILI SPECIALI	108	3014	PROFILI SPECIALI	108	3098	PROFILI SPECIALI	104
2232	CONTENITORE ELETTRONICA	3	3015	PROFILI SPECIALI	108	3099	PROFILI SPECIALI	104
2234	DISSIPATORE	18	3016	PROFILI SPECIALI	104	3100	PROFILI SPECIALI	105
2235	DISSIPATORE	13	3017	PROFILI SPECIALI	113	3101	PROFILI SPECIALI	104
2236	DISSIPATORE	59	3018	PROFILI SPECIALI	107	3102	PROFILI SPECIALI	104
2237	DISSIPATORE	59	3019	PROFILI SPECIALI	107	3103	PROFILI SPECIALI	105
2241	PROFILI SPECIALI	115	3020	PROFILI SPECIALI	114	3104	PROFILI SPECIALI	104
2243	PROFILI COMPONIBILI	72	3021	PROFILI SPECIALI	114	3105	PROFILI SPECIALI	104
2245	DISSIPATORE	61	3022	PROFILI SPECIALI	114	3106	PROFILI SPECIALI	104
2248	DISSIPATORE	6	3024	PROFILI SPECIALI	114	3107	PROFILI SPECIALI	104
2249	DISSIPATORE	25	3026/N	PROFILI SPECIALI	109	3108	PROFILI SPECIALI	104
2254	DISSIPATORE	65	3027/N	PROFILI SPECIALI	109	3109	PROFILI SPECIALI	104
2258	PROFILI SPECIALI	119	3028	PROFILI SPECIALI	109	3110	PROFILI SPECIALI	105
2261	CONTENITORE ELETTRONICA	5	3029	PROFILI SPECIALI	104	3111	PROFILI SPECIALI	105
2266	DISSIPATORE	8	3030	PROFILI SPECIALI	104	3112	PROFILI SPECIALI	104
2271	DISSIPATORE	58	3031	PROFILI SPECIALI	104	3113	PROFILI SPECIALI	104
2273	DISSIPATORE	8	3032	PROFILI SPECIALI	104	3114	PROFILI SPECIALI	104
2274	DISSIPATORE	57	3033	PROFILI SPECIALI	104	3115	PROFILI SPECIALI	105
2300	PROFILI PNEUMATICA	98	3034	PROFILI SPECIALI	104	3116	PROFILI SPECIALI	105
2318	PROFILI SPECIALI	112	3035	PROFILI SPECIALI	114	3117	PROFILI SPECIALI	122
2319	PROFILI SPECIALI	112	3037	PROFILI SPECIALI	108	3118	PROFILI SPECIALI	105
2320	PROFILI SPECIALI	114	3043	PROFILI SPECIALI	113	3119	PROFILI SPECIALI	105
2321	PROFILI SPECIALI	112	3044	PROFILI SPECIALI	113	3120	PROFILI SPECIALI	105
2322	PROFILI SPECIALI	112	3045	PROFILI SPECIALI	113	3121	PROFILI SPECIALI	105
2323	PROFILI SPECIALI	112	3046	PROFILI SPECIALI	113	3122	PROFILI SPECIALI	105
2324	PROFILI SPECIALI	112	3048	PROFILI SPECIALI	109	3123	PROFILI SPECIALI	105
2325	PROFILI SPECIALI	113	3050	PROFILI SPECIALI	106	3124/N	PROFILI SPECIALI	105
2326	PROFILI SPECIALI	112	3051	PROFILI SPECIALI	106	3125	PROFILI SPECIALI	107
2327	PROFILI SPECIALI	112	3052	PROFILI SPECIALI	106	3126	PROFILI SPECIALI	105
2328	PROFILI SPECIALI	112	3053	PROFILI SPECIALI	106	3127	PROFILI SPECIALI	122
2329	PROFILI SPECIALI	112	3054	PROFILI SPECIALI	106	3128	PROFILI SPECIALI	105
2331	PROFILI SPECIALI	112	3055	PROFILI SPECIALI	106	3129/N	PROFILI SPECIALI	107
2332	PROFILI SPECIALI	112	3056	PROFILI SPECIALI	106	3130	PROFILI SPECIALI	105
2333	PROFILI SPECIALI	112	3057	PROFILI SPECIALI	106	3131	PROFILI SPECIALI	105
2334	PROFILI SPECIALI	112	3058	PROFILI SPECIALI	106	3132	PROFILI SPECIALI	107
2335	PROFILI SPECIALI	112	3059	PROFILI SPECIALI	106	3133	PROFILI SPECIALI	108
2336	PROFILI SPECIALI	112	3060	PROFILI SPECIALI	106	3134	PROFILI SPECIALI	108
2338	PROFILI SPECIALI	112	3061	PROFILI SPECIALI	106	3135	PROFILI SPECIALI	108
2339	PROFILI SPECIALI	112	3062	PROFILI SPECIALI	106	3137	PROFILI SPECIALI	107
2340	PROFILI SPECIALI	112	3063	PROFILI SPECIALI	106	3138	PROFILI SPECIALI	107
2341	PROFILI SPECIALI	112	3064	PROFILI SPECIALI	108	3140	PROFILI SPECIALI	107
2342	PROFILI SPECIALI	113	3065	PROFILI SPECIALI	106	3141/N	PROFILI SPECIALI	104
2343	PROFILI SPECIALI	113	3066	PROFILI SPECIALI	106	3142	PROFILI SPECIALI	114
2344	PROFILI SPECIALI	112	3067	PROFILI SPECIALI	108	3143	PROFILI SPECIALI	104
2345	PROFILI SPECIALI	112	3068	PROFILI SPECIALI	106	3144	PROFILI SPECIALI	104
2346	PROFILI SPECIALI	112	3069	PROFILI SPECIALI	108	3145	PROFILI SPECIALI	114
2347	PROFILI SPECIALI	112	3070	PROFILI SPECIALI	108	3146	PROFILI SPECIALI	114
2348	PROFILI SPECIALI	112	3071	PROFILI SPECIALI	108	3147	PROFILI SPECIALI	119
2349	PROFILI SPECIALI	112	3072	PROFILI SPECIALI	106	3148	PROFILI SPECIALI	109
2350	PROFILI SPECIALI	112	3073	PROFILI SPECIALI	106	3149	PROFILI SPECIALI	109
2351	PROFILI SPECIALI	112	3074	PROFILI SPECIALI	106	3150	PROFILI SPECIALI	109
2352	PROFILI SPECIALI	112	3075	PROFILI SPECIALI	106	3151	PROFILI SPECIALI	109
2353	PROFILI SPECIALI	112	3076	PROFILI SPECIALI	106	3152	PROFILI SPECIALI	105
2354	PROFILI SPECIALI	114	3077	PROFILI SPECIALI	107	3153	PROFILI SPECIALI	107
2355	PROFILI SPECIALI	114	3078	PROFILI SPECIALI	107	3154	PROFILI SPECIALI	107
2356	PROFILI SPECIALI	114	3079	PROFILI SPECIALI	107	3155	PROFILI SPECIALI	107
2357	PROFILI SPECIALI	112	3080	PROFILI SPECIALI	107	3156	PROFILI SPECIALI	103
2358	PROFILI SPECIALI	112	3081/N	PROFILI SPECIALI	107	3157	PROFILI SPECIALI	119
2448	CONTENITORE ELETTRONICA	1	3082/N	PROFILI SPECIALI	105	3159	PROFILI SPECIALI	119
2496	CONTENITORE ELETTRONICA	1	3083	PROFILI SPECIALI	120	3160	PROFILI SPECIALI	109
3000	PROFILI STAND	70	3084	PROFILI SPECIALI	120	3161	PROFILI SPECIALI	109
3001	PROFILI SPECIALI	112	3085	PROFILI SPECIALI	120	3162	PROFILI SPECIALI	103

Via Newton, n.12
20016 Pero (Milano - Italy)
Tel. +39 02 3535955 r.a. Fax. +39 02 3539929
E.Mai: info@omar-alluminio.it

Cataloghi Online: www.omar-alluminio.it
www.omar-alluminio.com
PROFILATI ALLUMINIO A DISEGNO / STANDARD / SPECIALI / E PER:
ELETTRONICA / LED / FOTOVOLTAICO / AUTOMAZIONE ROBOTICA / PNEUMATICA / AUTOMOTIVE



Indice Articoli

Consultate il Catalogo aggiornato Online
all'indirizzo www.omar-alluminio.it

3163	PROFILI SPECIALI	107	3242	PROFILI SPECIALI	106	PNC80	PROFILI PNEUMATICI	96
3164	PROFILI SPECIALI	107	3243	PROFILI SPECIALI	106	PNCT100	PROFILI PNEUMATICI	97
3165	PROFILI SPECIALI	107	3244	PROFILI SPECIALI	106	PNCT32	PROFILI PNEUMATICI	97
3166	PROFILI SPECIALI	107	3245	PROFILI SPECIALI	106	PNCT40	PROFILI PNEUMATICI	97
3167	PROFILI SPECIALI	109	3246	PROFILI SPECIALI	106	PNCT50	PROFILI PNEUMATICI	97
3168	PROFILI SPECIALI	107	3247	PROFILI SPECIALI	106	PNCT63	PROFILI PNEUMATICI	97
3169	PROFILI SPECIALI	107	3248	PROFILI SPECIALI	106	PNCT80	PROFILI PNEUMATICI	97
3170	PROFILI SPECIALI	106	3249	PROFILI SPECIALI	106	PNLG100	PROFILI PNEUMATICI	95
3171	PROFILI SPECIALI	104	3250	PROFILI SPECIALI	106	PNLG125	PROFILI PNEUMATICI	95
3172	PROFILI SPECIALI	109	3251	PROFILI SPECIALI	112	PNLG32	PROFILI PNEUMATICI	95
3173	PROFILI SPECIALI	107	3252	PROFILI SPECIALI	106	PNLG40	PROFILI PNEUMATICI	95
3174	PROFILI SPECIALI	107	3253	PROFILI SPECIALI	106	PNLG50	PROFILI PNEUMATICI	95
3175	PROFILI SPECIALI	107	3254	PROFILI SPECIALI	113	PNLG63	PROFILI PNEUMATICI	95
3176	PROFILI SPECIALI	119	3256	PROFILI SPECIALI	113	PNM80125	PROFILI PNEUMATICI	86
3177	PROFILI SPECIALI	104	3257	PROFILI SPECIALI	106	PNM8020	PROFILI PNEUMATICI	85
3178	PROFILI SPECIALI	105	3259	PROFILI SPECIALI	106	PNM8025	PROFILI PNEUMATICI	85
3179	PROFILI SPECIALI	105	3260	PROFILI SPECIALI	106	PNM89100	PROFILI PNEUMATICI	89
3180	PROFILI SPECIALI	107	3261	PROFILI SPECIALI	106	PNM89125	PROFILI PNEUMATICI	89
3181	PROFILI SPECIALI	107	3262	PROFILI SPECIALI	106	PNM89160	PROFILI PNEUMATICI	86
3182	PROFILI SPECIALI	108	3263	PROFILI SPECIALI	106	PNM89200	PROFILI PNEUMATICI	87
3183	PROFILI SPECIALI	107	3264	PROFILI SPECIALI	106	PNM8932	PROFILI PNEUMATICI	88
3184	PROFILI SPECIALI	108	3265	PROFILI SPECIALI	108	PNM8940	PROFILI PNEUMATICI	88
3185	PROFILI SPECIALI	104	3266	PROFILI SPECIALI	106	PNM8950	PROFILI PNEUMATICI	88
3187	PROFILI SPECIALI	114	3267	PROFILI SPECIALI	106	PNM8963	PROFILI PNEUMATICI	88
3188	PROFILI SPECIALI	104	3268	PROFILI SPECIALI	106	PNM8980	PROFILI PNEUMATICI	89
3189/N	PROFILI SPECIALI	107	3269	PROFILI SPECIALI	106	PNM90100	PROFILI PNEUMATICI	85
3190	PROFILI SPECIALI	107	3270	PROFILI SPECIALI	112	PNM9032	PROFILI PNEUMATICI	85
3191	PROFILI SPECIALI	107	3271	PROFILI RACLE	120	PNM9040	PROFILI PNEUMATICI	85
3192	PROFILI SPECIALI	113	3272	PROFILI RACLE	120	PNM9050	PROFILI PNEUMATICI	85
3193	PROFILI SPECIALI	107	3307	PROFILI SPECIALI	108	PNM9063	PROFILI PNEUMATICI	85
3194	PROFILI SPECIALI	107	3308	PROFILI SPECIALI	121	PNM9080	PROFILI PNEUMATICI	85
3195	PROFILI SPECIALI	107	3309	PROFILI SPECIALI	121	PNP94100	PROFILI PNEUMATICI	94
3196	PROFILI SPECIALI	107	3310	PROFILI SPECIALI	105	PNP9416	PROFILI PNEUMATICI	93
3197	PROFILI SPECIALI	107	3311	PROFILI SPECIALI	110	PNP9420	PROFILI PNEUMATICI	93
3199	PROFILI SPECIALI	107	3312	PROFILI SPECIALI	110	PNP9425	PROFILI PNEUMATICI	93
3200	PROFILI SPECIALI	120	3313	PROFILI SPECIALI	110	PNP9432	PROFILI PNEUMATICI	93
3201	PROFILI SPECIALI	120	3314	PROFILI SPECIALI	109	PNP9440	PROFILI PNEUMATICI	93
3202	PROFILI SPECIALI	105	3315	PROFILI SPECIALI	110	PNP9450	PROFILI PNEUMATICI	93
3203	PROFILI SPECIALI	109	3316	PROFILI SPECIALI	110	PNP9463	PROFILI PNEUMATICI	93
3204	PROFILI SPECIALI	109	3317	PROFILI SPECIALI	110	PNP9480	PROFILI PNEUMATICI	93
3205	PROFILI SPECIALI	109	3318	PROFILI SPECIALI	111	PNR99100	PROFILI PNEUMATICI	91
3209	PROFILI SPECIALI	109	3319	PROFILI SPECIALI	111	PNR99125	PROFILI PNEUMATICI	92
3210	PROFILI SPECIALI	109	3320	PROFILI SPECIALI	111	PNR9932	PROFILI PNEUMATICI	90
3211	PROFILI SPECIALI	109	3321	PROFILI SPECIALI	111	PNR9940	PROFILI PNEUMATICI	90
3212	PROFILI SPECIALI	109	3322	PROFILI SPECIALI	111	PNR9950	PROFILI PNEUMATICI	90
3213	PROFILI SPECIALI	109	3323	PROFILI SPECIALI	111	PNR9963	PROFILI PNEUMATICI	90
3214	PROFILI SPECIALI	104	3324	PROFILI SPECIALI	111	PNR9980	PROFILI PNEUMATICI	91
3215	PROFILI SPECIALI	104	3325	PROFILI SPECIALI	111	PNT100106	PROFILI PNEUMATICI	94
3216	PROFILI SPECIALI	107	3326	PROFILI SPECIALI	111	PNT100107	PROFILI PNEUMATICI	94
3217	PROFILI SPECIALI	105	3672	CONTENITORE ELETTRONICA	1	PNT105110	PROFILI PNEUMATICI	94
3218	PROFILI SPECIALI	104	3696	CONTENITORE ELETTRONICA	1	PNT1216	PROFILI PNEUMATICI	94
3219	PROFILI SPECIALI	104	4848	CONTENITORE ELETTRONICA	1	PNT125131	PROFILI PNEUMATICI	94
3221	PROFILI SPECIALI	103	4896	CONTENITORE ELETTRONICA	1	PNT125132	PROFILI PNEUMATICI	94
3222	PROFILI SPECIALI	103	7272	CONTENITORE ELETTRONICA	1	PNT150160	PROFILI PNEUMATICI	94
3223	PROFILI SPECIALI	103	9696	CONTENITORE ELETTRONICA	1	PNT160170	PROFILI PNEUMATICI	94
3224	PROFILI SPECIALI	103	36144	CONTENITORE ELETTRONICA	1	PNT1620	PROFILI PNEUMATICI	94
3225	PROFILI SPECIALI	103	48192	CONTENITORE ELETTRONICA	2	PNT200210	PROFILI PNEUMATICI	94
3226	PROFILI SPECIALI	104	50144	CONTENITORE ELETTRONICA	1	PNT2024	PROFILI PNEUMATICI	94
3228	PROFILI SPECIALI	105	72144	CONTENITORE ELETTRONICA	1	PNT2025	PROFILI PNEUMATICI	94
3229	PROFILI SPECIALI	122	72216	CONTENITORE ELETTRONICA	4	PNT2529	PROFILI PNEUMATICI	94
3230	PROFILI SPECIALI	104	96192	CONTENITORE ELETTRONICA	2	PNT2530	PROFILI PNEUMATICI	94
3231	PROFILI SPECIALI	108	96216	CONTENITORE ELETTRONICA	4	PNT3236	PROFILI PNEUMATICI	94
3232	PROFILI SPECIALI	107	96288	CONTENITORE ELETTRONICA	3	PNT3238	PROFILI PNEUMATICI	94
3234	PROFILI SPECIALI	120	144144	CONTENITORE ELETTRONICA	1	PNT3540	PROFILI PNEUMATICI	94
3235	PROFILI SPECIALI	120	192192	CONTENITORE ELETTRONICA	2	PNT3640	PROFILI PNEUMATICI	94
3236	PROFILI SPECIALI	120	192216	CONTENITORE ELETTRONICA	4	PNT4044	PROFILI PNEUMATICI	94
3237	PROFILI SPECIALI	104	PNC100	PROFILI PNEUMATICI	96	PNT4045	PROFILI PNEUMATICI	94
3238	PROFILI SPECIALI	104	PNC32	PROFILI PNEUMATICI	96	PNT5054	PROFILI PNEUMATICI	94
3239	PROFILI SPECIALI	107	PNC40	PROFILI PNEUMATICI	96	PNT5055	PROFILI PNEUMATICI	94
3240	PROFILI SPECIALI	106	PNC50	PROFILI PNEUMATICI	96	PNT5057	PROFILI PNEUMATICI	94
3241	PROFILI SPECIALI	106	PNC63	PROFILI PNEUMATICI	96	PNT5060	PROFILI PNEUMATICI	94

Tipo di matrici di estrusione

Extrusion tools

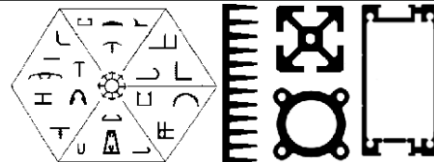

Via Newton, n. 12
20016 Pero (Milano - Italy)
Tel. +39 02 3535955 r.a. Fax. +39 02 3539929
E.Mai: info@omar-alluminio.it

Cataloghi Online: www.omar-alluminio.it
www.omar-alluminio.com
PROFILATI ALLUMINIO A DISEGNO / STANDARD / SPECIALI / E PER:
ELETTRONICA / LED / FOTOVOLTAICO / AUTOMAZIONE ROBOTICA / PNEUMATICA / AUTOMOTIVE

A) matrice piana per
profilato aperto

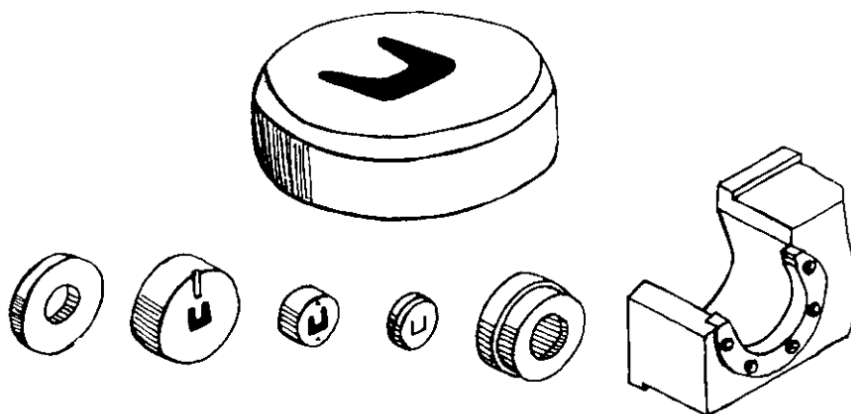

B) matrice Spyder per
profilato cavo

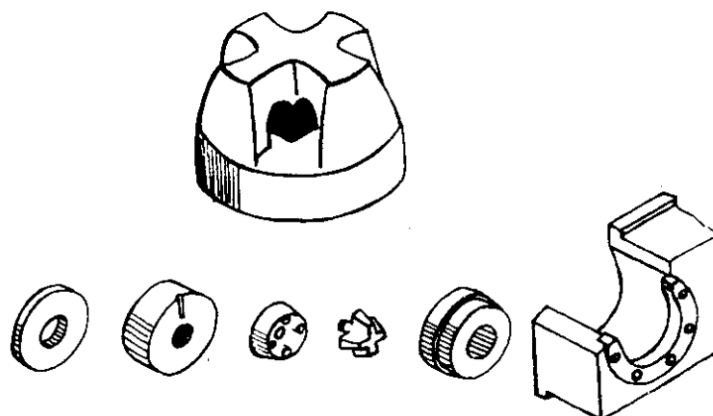

C) matrice Porthole
per profilato cavo

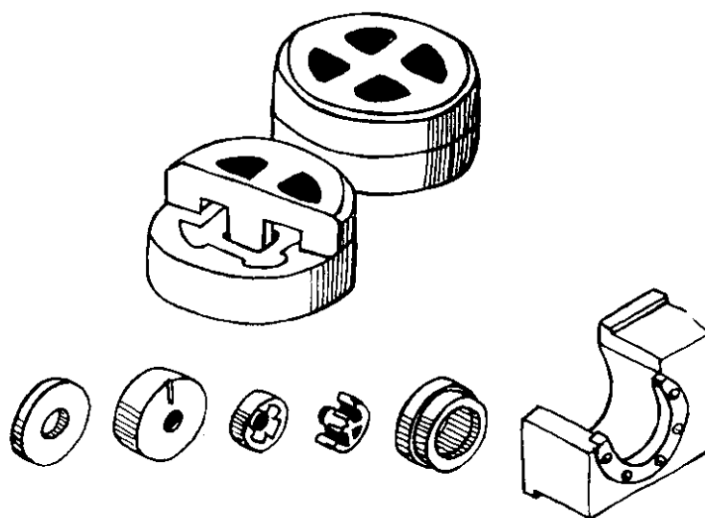

D) matrice a Ponte simile
a Porthole per profilato cavo

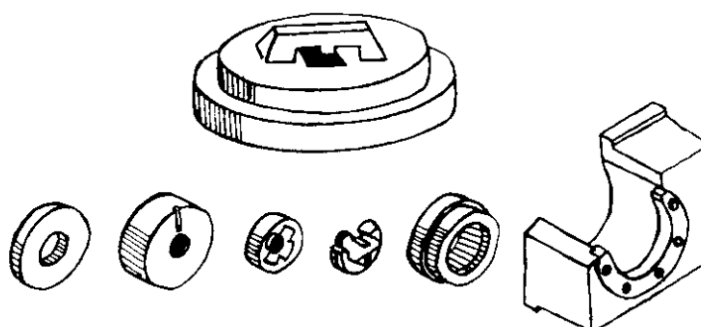

- DIMENSIONI MASSIME ESTRUDIBILI -

SCALA 1:3

470

330

R145

R90

PRESSA 3200 TON

PRESSA 6050 TON

450

630

Principali leghe da estrusione

Extrusion aluminium alloy proprieties

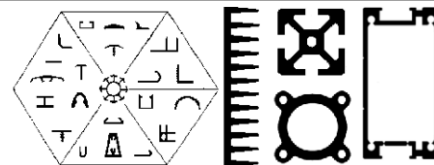

Via Newton, n. 12
20016 Pero (Milano - Italy)
Tel. +39 02 3535955 r.a. Fax. +39 02 3539929
E-Mail: info@omar-alluminio.it

Cataloghi Online: www.omar-alluminio.it
www.omar-alluminio.com
PROFILATI ALLUMINIO A DISEGNO / STANDARD / SPECIALI / E PER:
ELETTRONICA / LED / FOTOVOLTAICO / AUTOMAZIONE ROBOTICA / PNEUMATICA / AUTOMOTIVE

Caratteristiche fisiche

Massa volumica	2,70	Gr/cm3	Conducibilità termica a 20°C	Nello stato 0: 2,09 W/cm °Kelvin Nello stato T6: 1,75 W/cm °Kelvin
Punto di fusione inferiore	605	C	Coeff. Di dilatazione termica lineare	Tra 20° e 100°C: 23,0 -10-6 1°/Kelvin Tra 20° e 200°C: 24,0 -10-6 1°/Kelvin Tra 20° e 300°C: 25,0 -10-6 1°/Kelvin
Calore specifico tra 0° e 100°C	890	Joule/Kg °Kelvin	Resistività elettrica a 20°C	Nello stato 0: 3,14 microOhm *cm Nello stato T6: 3,25 microOhm *cm
Modulo di elasticità lineare E	69000	Newton/mm2		
Modulo di elasticità tangenziale G	26000	Newton/mm2		

Tipo profilo	(1) stato fisico di fornitura	Diametro D		Carico	Di rottura a	Carico di	Rottura a	Allungamento			
		o spess. S	[mm] per tondi,					Trazione	Rm [Mpa]	A %	A50 mm%
		o spess. Di parete	[mm] per barre,					min	max	min	max
tondi e barre plane	T4 (*)	D ≤150	S ≤150	120	-	60	-	16	14		
	T5	D ≤150	S ≤150	160	-	120	-	8	6		
	T6 (*)	D ≤150	S ≤150	190	-	150	-	8	6		
	T64 (*)	D ≤50	S ≤50	180	-	120	-	12	10		
	T66 (*)	D ≤150	S ≤150	215	-	160	-	8	6		
tubi	T4(*)	e ≤15		120	-	60	-	16	14		
	T5	e ≤15		160	-	120	-	8	6		
	T6(*)	e ≤15		190	-	150	-	8	6		
	T64(*)	e ≤15		180	-	120	-	12	10		
	T66(*)	e ≤15		215	-	160	-	8	6		
Profili aperti e cavi	T4 (*)	e ≤25		120	-	60	-	16	14		
	T5	e ≤5		160	-	120	-	8	6		
		5 < e ≤ 25		140	-	100	-	8	6		
	T6 (*)	e ≤3		190	-	150	-	8	6		
		3 < e ≤ 25		170	-	140	-	8	6		
	T64 (*)	e ≤15		180	-	120	-	12	10		
	T66 (*)	e ≤3		215	-	160	-	8	6		
3 < e ≤ 25			195	-	150	-	8	6			

LEGA	Stato fisico	Deformabilità plastica		Lavorabilità su macchina utensile	Saldabilità	Lucidabilità	Ossidazione	anodica		Resistenza alla corrosione		
		a freddo	a caldo					protettiva	decorativa	urbana	industriale	marina
EN AW-3103	F,H 112	2	1	5	3	4	3	3	1	1	2	
	O,H 111	2	1	5	3	4	3	3	1	1	2	
EN AW-6060	O	2	1	5	2	4	1	2	1	2	2	
	T1,T4	3	2	4	2	3	1	1	1	2	2	
	T5,T6	4	X	3	2	2	1	1	1	2	2	
EN AW-6063	O,H 111	2	1	5	2	4	1	2	2	2	3	
	T4	3	2	4	2	3	1	1	2	2	3	
	T5,T6	4	X	3	2	2	1	1	2	2	3	
EN AW-6005A	O	2	1	4	2	3	2	4	2	3	3	
	T4	3	2	3	2	2	2	3	2	3	3	
	T5,T6	4	X	2	2	1	2	3	2	3	3	
EN AW-6082	O,H 111	2	1	4	2	3	2	3	3	3	3	
	T4	3	2	3	2	2	2	2	3	3	3	
	T5,T6	4	X	2	2	1	2	2	3	3	3	

INDICE DI VALUTAZIONE: 1=OTTIMO 2=BUONO 3=SUFFICIENTE 4=MEDIOCRE 5=SCARSO X=NON APPLICABILE AGLI STATI T5 E T6



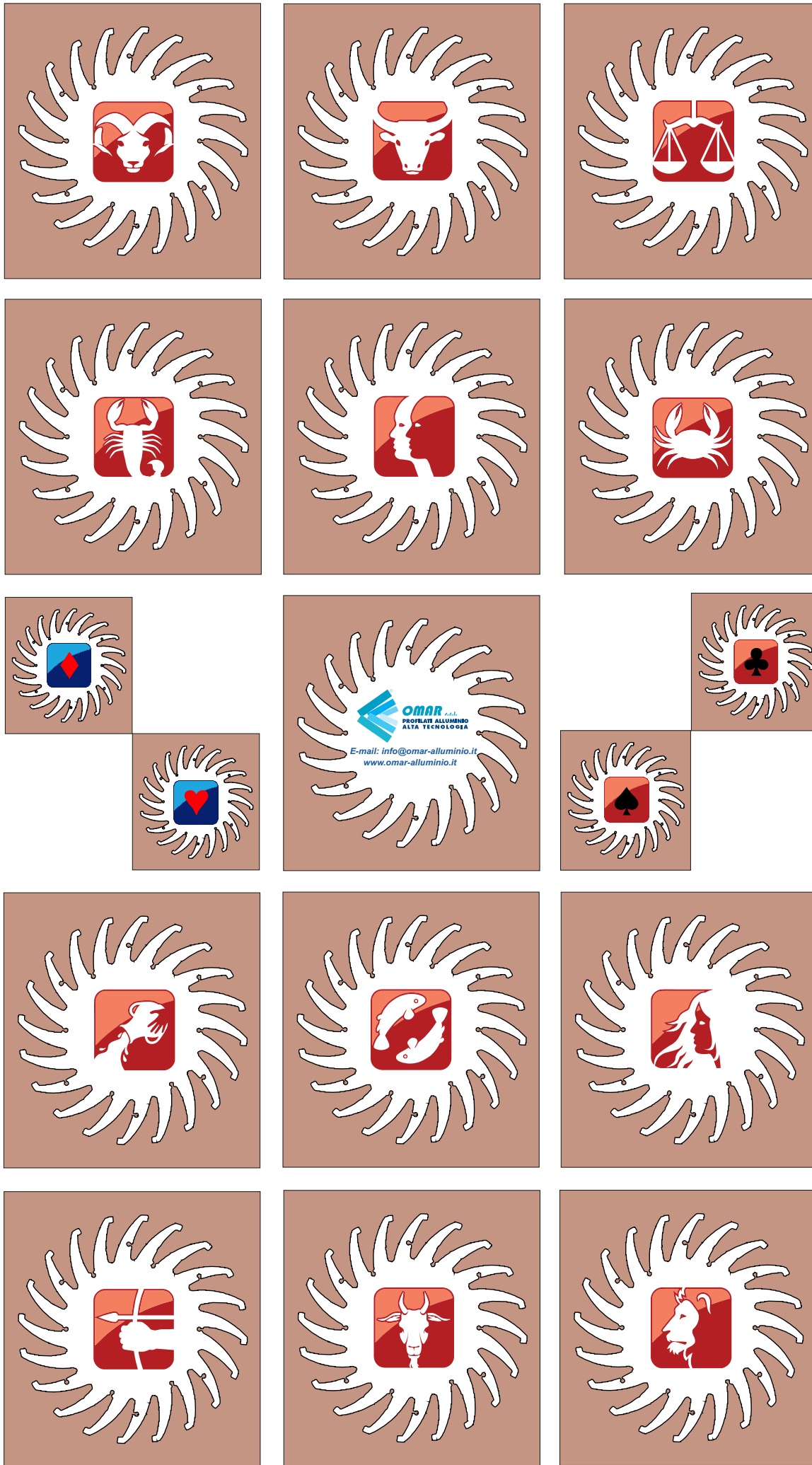

Tab.10

AGGIORNAMENTO CONTINUO - ED. DEL 02-2017



Cataloghi Online: www.omar-alluminio.it
www.omar-alluminio.com

PROFILATI ALLUMINIO A DISEGNO / STANDARD / SPECIALI / E PER:
 ELETTRONICA / LED / FOTOVOLTAICO / AUTOMAZIONE ROBOTICA / PNEUMATICA / AUTOMOTIVE

Via Newton, n.12
 20016 Pero (Milano - Italy)
 Tel. +39 02 3535955 r.a. Fax. +39 02 3539929
 E-Mail: info@omar-alluminio.it

FIERA MILANO RHO - PERO

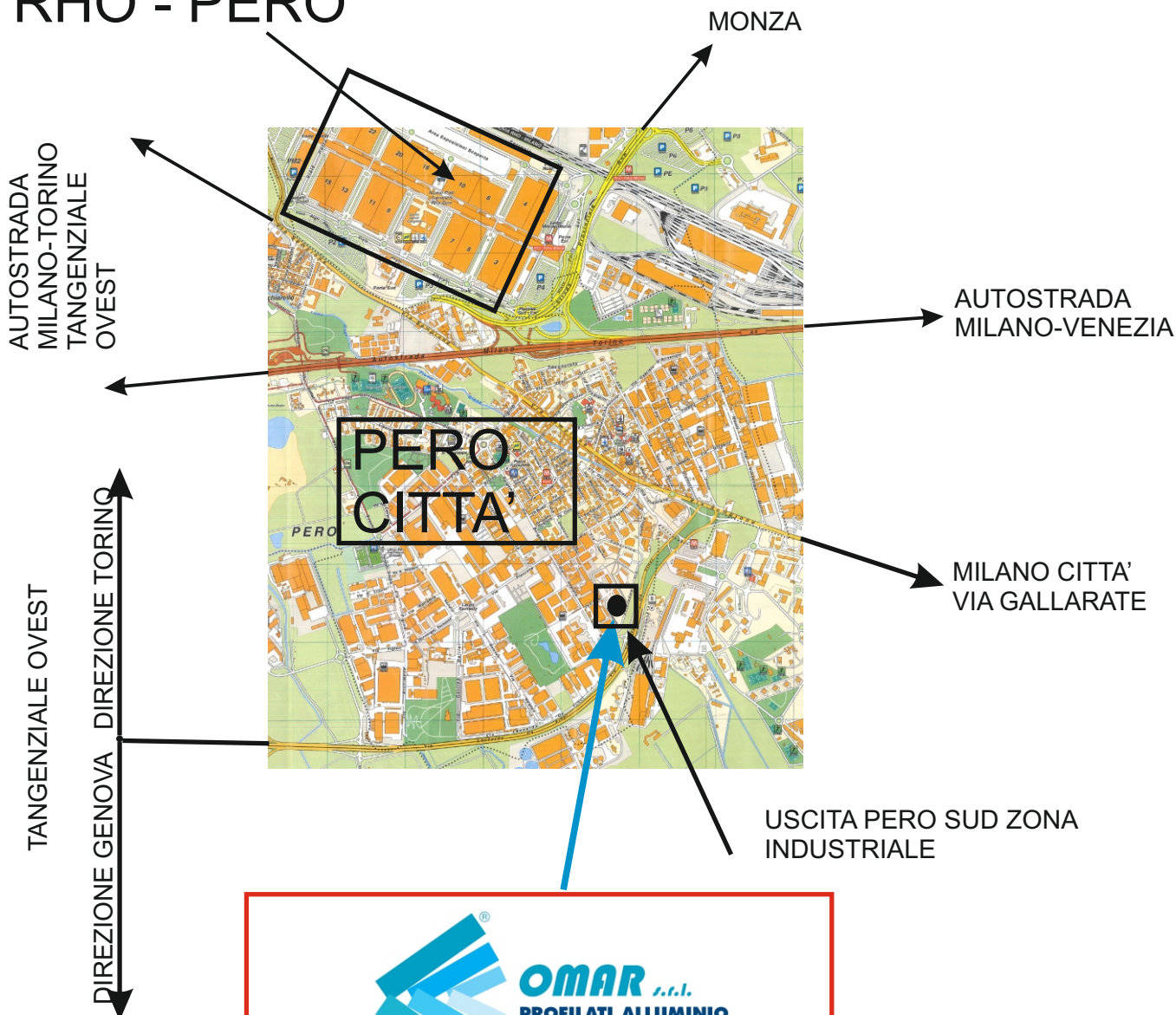

OMAR s.r.l.
PROFILATI ALLUMINIO
ALTA TECNOLOGIA

Via Newton, n.12
20016 Pero (Milano - Italy)
Tel.+39 02 3535955 r.a.
Fax.+39 02 3539929
E.Mail: info@omar-alluminio.it

Consultate il ns. catalogo aggiornato online all'indirizzo:

www.omar-alluminio.it

www.omar-alluminio.com

www.omar-alluminio.eu

PROFILATI IN ALLUMINIO
A DISEGNO-STANDARD-SPECIALI



E PER: ELETTRONICA-LED-FOTOVOLTAICO
AUTOMAZIONE ROBOTICA-PNEUMATICA-AUTOMOTIVE